



Office

Social distance Products

DESIGN & SOLUTIONS



NON DISCLOSURE AGREEMENT

All information, design, graphics and solutions contained in this book are property of Flex Italy and it has to be treated as strictly confidential and can not be disclosed to third parties, without written authorization from Flex S.r.l. Italy.

FLEX - SOCIAL DISTANCE

Thanks to the synergy between Design and functionality, Flex created the range of protective solutions for the office. The purpose of these solutions is to guarantee the security and protection of operators and customers. The Tendiflex post and the partitions guarantee safety inside the spaces while maintaining the elegance of the environment.



- 1 TENDIFLEX SPORT ;
- 2 PROTECTIVE PARTITION;
- 3 FREESTANDING PROTECTIVE PARTITION ;
- 4 THE FREESTANDING PROTECTIVE WALL;
- 5 SPRAY HOLDER FOR TENDIFLEX ;
- 6 DISPENSER HOLDER FOR TENDIFLEX;
- 7 SPRAY SIGN HOLDER WALL MOUNTED ;
- 8 DISPENSER SIGN HOLDER WALL MOUNTED;
- 9 SIGN DESK.

1 TENDIFLEX® SPORT

Social distance

The original TENDIFLEX® SPORT post with retractable belt represent the ideal solution to handle the environments with intense pedestrian traffic.

The sporty design and the special ultra-resistant and ultra-flat base makes them unbeatable in terms of durability and robustness, while the extendable belt is equipped with a magnetic tape end to fulfill security rules.

The TENDIFLEX® SPORT post has a practical shockproof transparent message holder panel, fixed above the upright and used as a directional support or to communicate information to the customer. This system allows you to have a communication that can be updated in a few seconds, guaranteeing customers effective service indications.



5 SPRAY SIGN HOLDER FOR TENDIFLEX® Social distance

Flex created a new **SANITIZING SPRAY HOLDER** system to be placed on our **TENDIFLEX SPORT** and **CLASSIC** posts. It is a support provided with a sign holder that can be customized on both sides, the systems are, **SignLine** which allows a quick replacement of the message inside the panel or the custom graphic panel. The product is designed to hold the Sanitizing Spray Flex and is equipped with security Velcro tape. **SPRAY SIGN HOLDER** has a unique design, in perfect **FLEX** style.



EXAMPLE OF USE

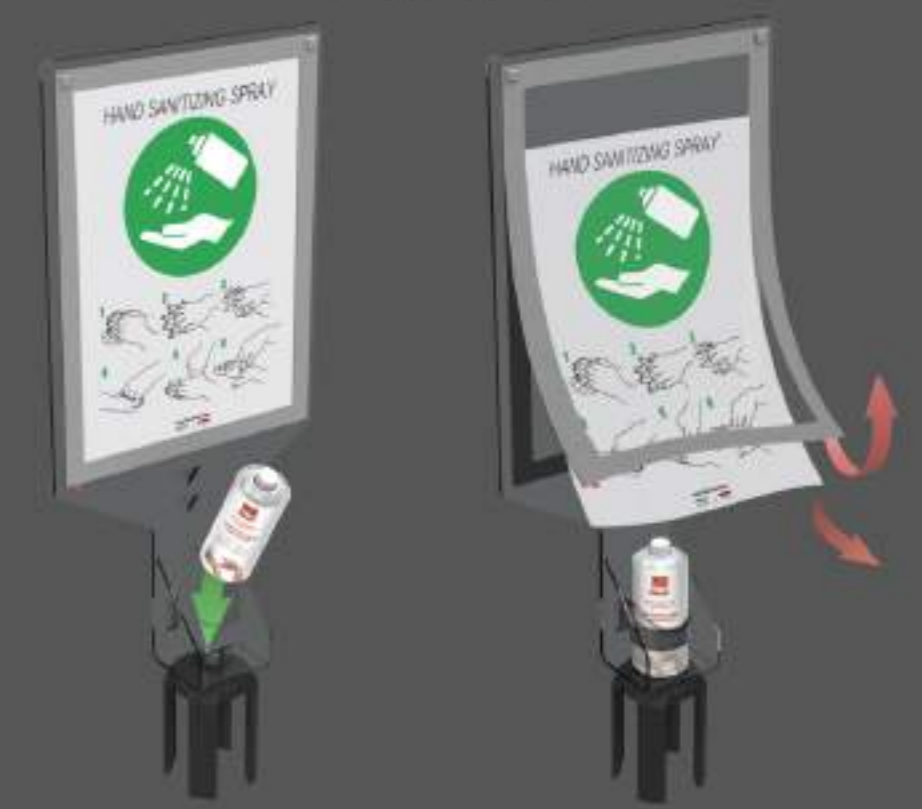

QUICK POSTER REPLACEMENT: OPEN, REMOVE AND REPLACE



ACCESSORY:
pocket sanitizing spray (not included), alcohol-based, quick action.
Directions for use: shake the bottle, spray on the surfaces to be treated.
ALL SANITIZING PRODUCTS ARE SOLD SEPARATELY

5 SPRAY SIGN HOLDER FOR TENDIFLEX®

Social distance



MESSAGE A4V FORMAT
(DOUBLE SIDED)
PAPER POSTER INCLUDED



Version with message change



CUSTOMIZED PANEL
(DOUBLE SIDED)
ADHESIVE FILM INCLUDED

Version with adhesive film

6 DISPENSER SIGN HOLDER FOR TENDIFLEX®

Social distance

Ideal to support the sanitary products of your choice, the DISPENSER SIGN HOLDER is equipped with a support adaptable to the TENDIFLEX SPORT and CLASSIC posts. Among the plus, to be underlined is the support shelf with side rails that thanks to its open edges guarantees a quick and incisive cleaning. Thanks to the Velcro safety tape, we can avoid the fall of the sanitizing Spray Flex due to involuntary impacts. The double-sided sign holder is fully customizable thanks to the SignLine message exchange system or you can choose the personalized graphic panel.



EXAMPLE OF USE



QUICK POSTER REPLACEMENT: OPEN, REMOVE AND REPLACE



ACCESSORY:
pocket sanitizing spray (not included), alcohol-based, quick action.
Directions for use: shake the bottle, spray on the surfaces to be treated.
ALL SANITIZING PRODUCTS ARE SOLD SEPARATELY

6 DISPENSER SIGN HOLDER FOR TENDIFLEX®

Social distance



MESSAGE A4V FORMAT
(DOUBLE SIDED)
PAPER POSTER INCLUDED



Version with message change



CUSTOMIZED PANEL
(DOUBLE SIDED)
ADHESIVE FILM INCLUDED

Version with adhesive film

18 AUTOMATIC DISPENSER FOR TENDIFLEX® SPORT

Social distance

Flex created a new AUTOMATIC DISPENSER system to be placed on our TENDIFLEX SPORT or CLASSIC posts. It is a support provided with a sign holder that can be customized on both sides, the systems are: SignLine which allows a quick replacement of the message inside the panel or the custom graphic panel. The product is designed to hold the automatic gel dispenser (600 ml). AUTOMATIC DISPENSER has a unique design, in perfect FLEX style.

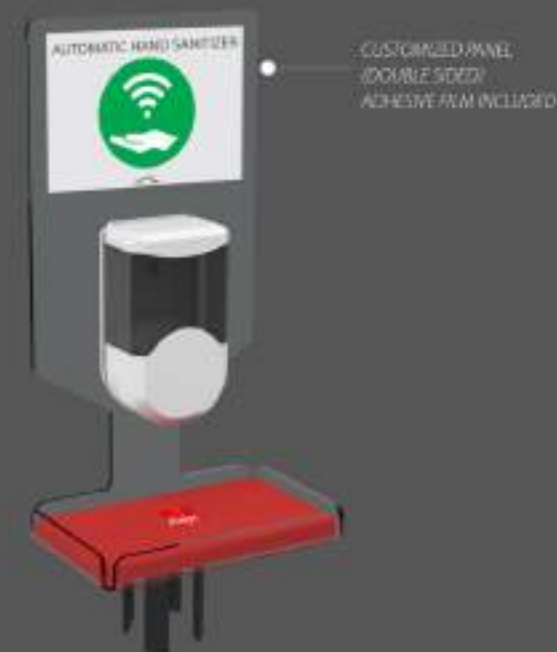

Version with message change



Version with adhesive film



1a TENDIFLEX® SPHERE

Social distance

The TENDIFLEX SPHERE post can be customized in many ways, from the customization of the cap to the one of the upper ring of the sphere which make each SPHERE unique.

The personalized rings of the sphere allow you to recall your company colors or the characteristics of your environment, making the product perfectly coordinated and recognizable.

The quick and simple change of the cap of the new TENDIFLEX SPHERE allows in few seconds to give a new look to the product making it perfect for any situation.

Company logos, graphics for special events, images and colors, texts and directional signs are just some of the possible uses.

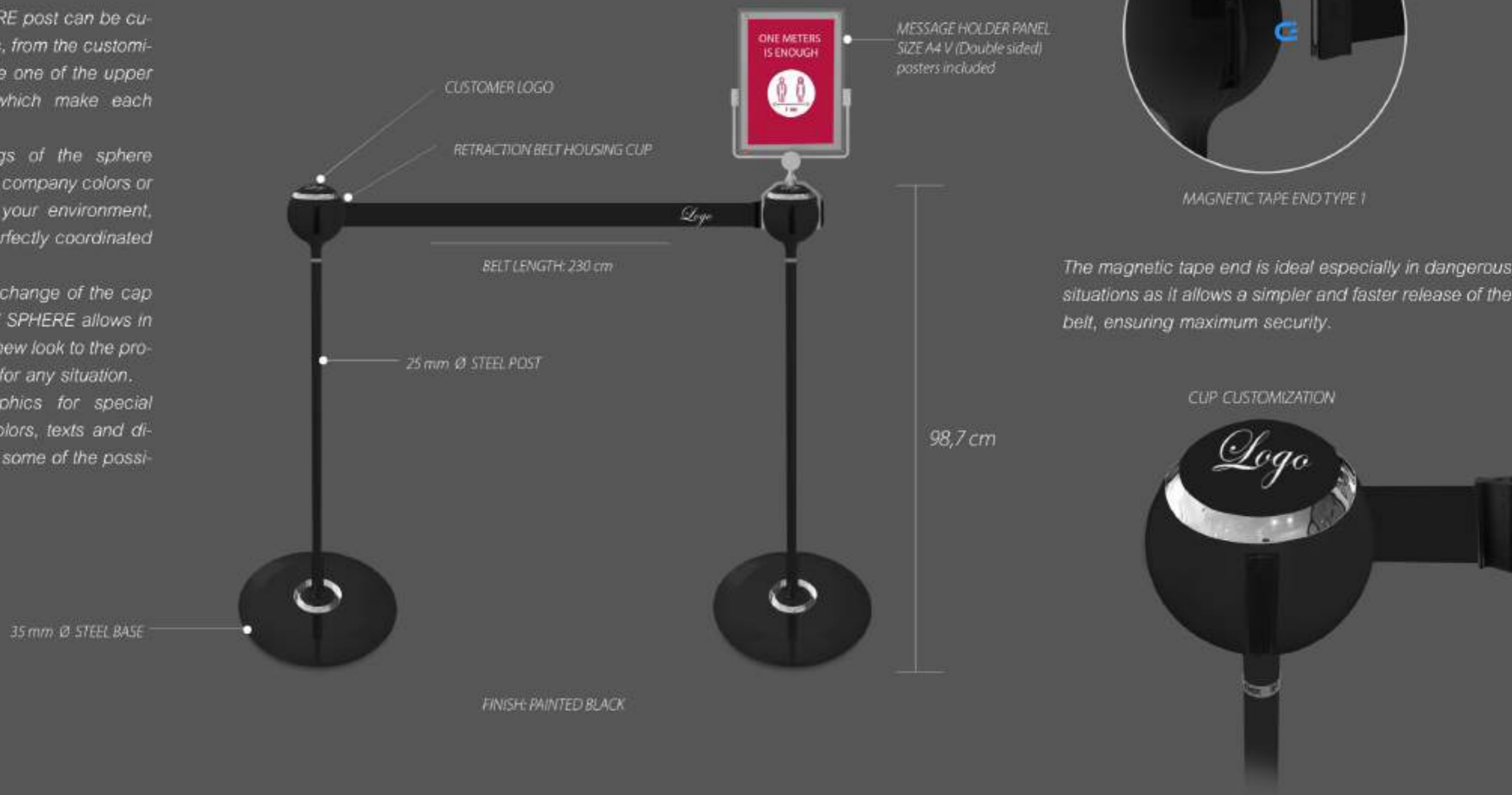

The magnetic tape end is ideal especially in dangerous situations as it allows a simpler and faster release of the belt, ensuring maximum security.

TENDIFLEX® SPHERE - AVAILABLE COLORS

Social Distance

SOFIA model

Sphere: black
Post: black
Base: black



Details and webbing:
RED



Details and webbing:
BLUE



Details and webbing:
FLUO PINK



Details: POLISHED CHROME
Webbing: BLACK

TENDIFLEX® SPHERE - AVAILABLE COLORS

Social Distance

REBECCA_1 model

Sphere: white
Post: white
Base: polished chrome



Details and webbing:
RED



Details and webbing:
BLUE



Details and webbing:
FLUO PINK

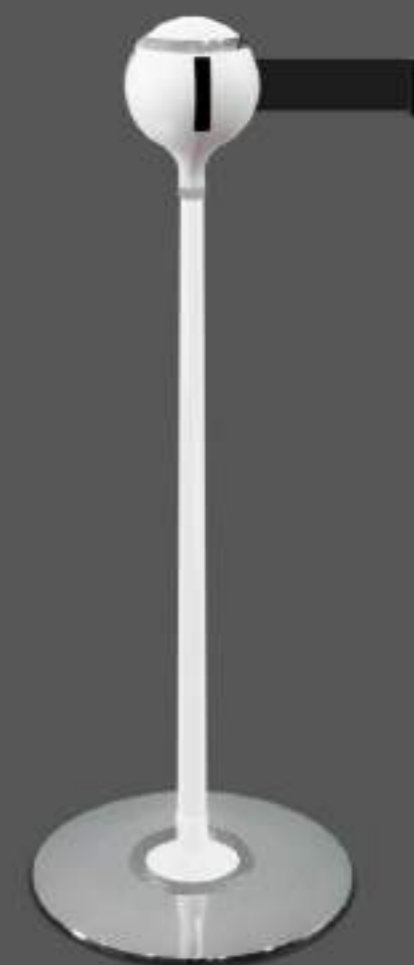

Details: POLISHED CHROME
Webbing: BLACK

TENDIFLEX® SPHERE - AVAILABLE COLORS

Social Distance

REBECCA_2 model

Sphere: white
Post: white
Base: black



Details and webbing:
RED



Details and webbing:
BLUE



Details and webbing:
FLUO PINK



Details: POLISHED CHROME
Webbing: BLACK

TENDIFLEX® SPHERE - AVAILABLE COLORS

Social Distance

MARGHERITA model

Sphere: polished chrome
Post: polished chrome
Base: polished chrome



Details and webbing:
RED



Details and webbing:
BLUE



Details and webbing:
FLUO PINK



Details: POLISHED CHROME
Webbing: BLACK

TENDIFLEX® SPHERE MINI

Social distance

The quick and simple change of the cap of the new TENDIFLEX® SPHERE allows in a few seconds to give a new look to the product and make it perfect for any situation and environment. Company logos, event graphics, images, colors, texts and even directional wayfinding are just some of the possible uses that this innovative product allows, in addition to its native function of managing pedestrian traffic within the environments in which it is located.



6a DISPENSER SIGN HOLDER FOR TENDIFLEX® SPHERE

Social distance

Ideal to support the sanitary products of your choice, the DISPENSER SIGN HOLDER is equipped with a support adaptable to the TENDIFLEX SPHERE posts. Among the plus, to be underlined is the support shelf with side rails that thanks to its open edges guarantees a quick and incisive cleaning. Thanks to the Velcro safety tape, we can avoid the fall of the sanitizing Spray Flex due to involuntary impacts.

The double-sided sign holder is fully customizable thanks to the SignLine message exchange system or you can choose the personalized graphic panel.



ACCESSORY:
pocket sanitizing spray (not included), alcohol-based, quick action.
Directions for use: shake the bottle, spray on the surfaces to be treated.
ALL SANITIZING PRODUCTS ARE SOLD SEPARATELY

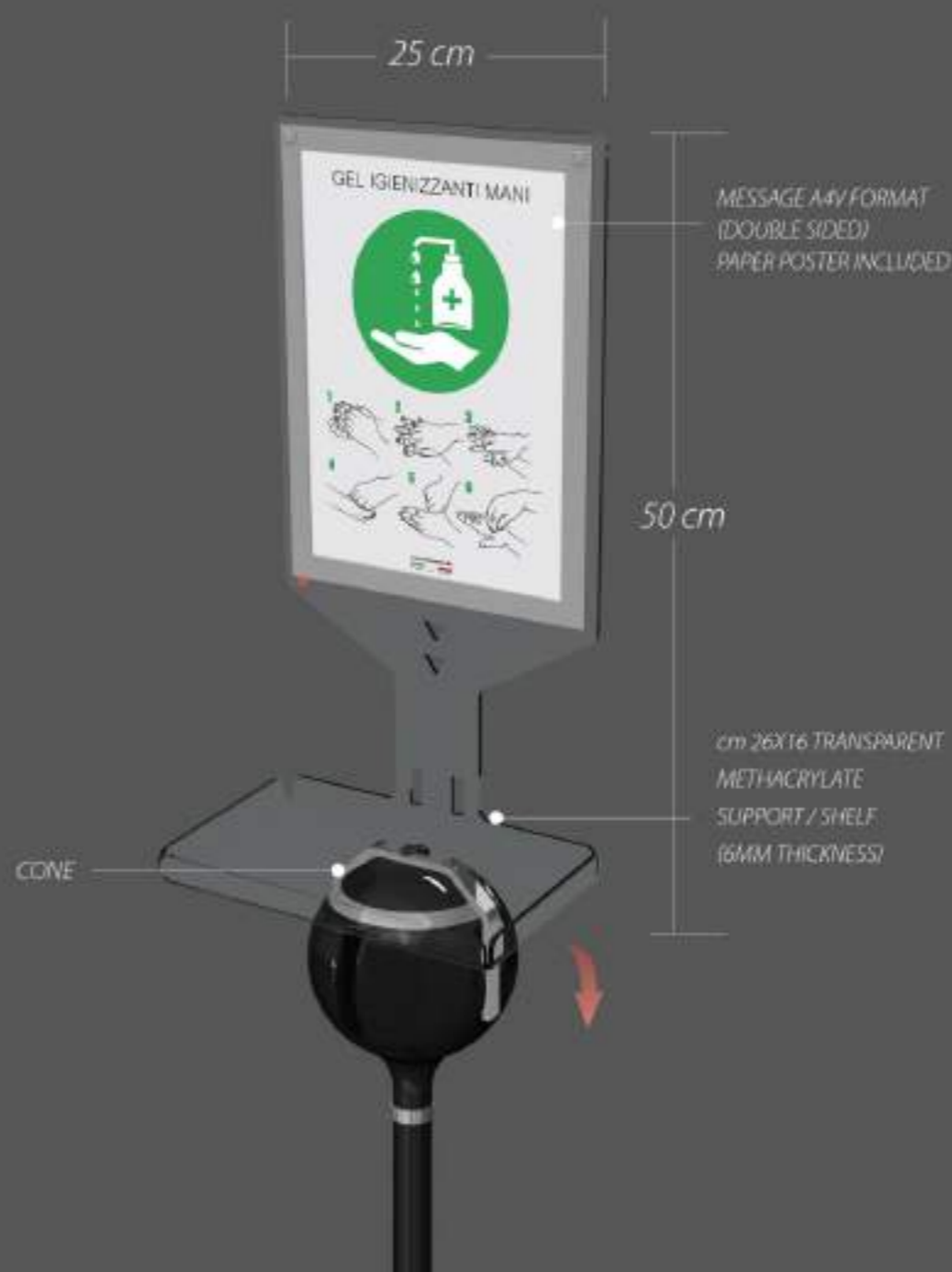

Version with message change



Version with adhesive film

5a SPRAY SIGN HOLDER FOR TENDIFLEX® SPHERE

Social distance

Flex created a new *SANITIZING SPRAY HOLDER* system to be placed on our *TENDIFLEX SPHERE* posts. It is a support provided with a sign holder that can be customized on both sides, the systems are, *SignLine* which allows a quick replacement of the message inside the panel or the custom graphic panel. The product is designed to hold the *Sanitizing Spray Flex* and is equipped with security *Velcro* tape. *SPRAY SIGN HOLDER* has a unique design, in perfect *FLEX* style.



Version with message change



Version with adhesive film



ACCESSORY:
pocket sanitizing spray (not included), alcohol-based, quick action.
Directions for use: shake the bottle, spray on the surfaces to be treated.
ALL SANITIZING PRODUCTS ARE SOLD SEPARATELY

17 AUTOMATIC DISPENSER FOR TENDIFLEX® SPHERE

Social distance

Flex created a new AUTOMATIC DISPENSER system to be placed on our TENDIFLEX SPHERE posts. It is a support provided with a sign holder that can be customized on both sides, the systems are: SignLine which allows a quick replacement of the message inside the panel or the custom graphic panel. The product is designed to hold the automatic gel dispenser (600 ml). AUTOMATIC DISPENSER has a unique design, in perfect FLEX style.



Version with message change



Version with adhesive film



12 THERMOSCANNER

Social distance

Integrated body measurement systems based on infrared thermal imaging technology take advantage of deep learning algorithms and Artificial Intelligence. They guarantee high performance and high reliability. These systems offer rapid recognition of the person thanks to face reading and combine body temperature data to report any state of alteration. The integrated system can be mounted at the access gates and it works in total autonomy without the presence of operators on site. Automatically records cases of high temperature and counts detection events. Rapid face recognition in the absence of protective masks. Allows the detection of thermal data even in the presence of a mask. It allows data uploading via network for image management and works in the event of a network failure. High temperature measurement accuracy with tolerance of ± 0.3 ° C.



2 PROTECTIVE PARTITION

Social distance

The Flex protective partition is a new product which, placed at the counter, at the cash desks or at the desk of an office or a shop, helps protect workers from direct contacts with the public.

The Flex protective partition is provided by a slot created for the passage of not bulky parcels or documents. It is a solution in transparent methacrylate that is perfectly suitable to the environment in which it is inserted. Its standard dimensions are 85 cm of base and 70 cm of height and has been designed to protect the customer and the operator from any direct contact. The product is equipped with two supporting pedestals that make it stable and resistant.

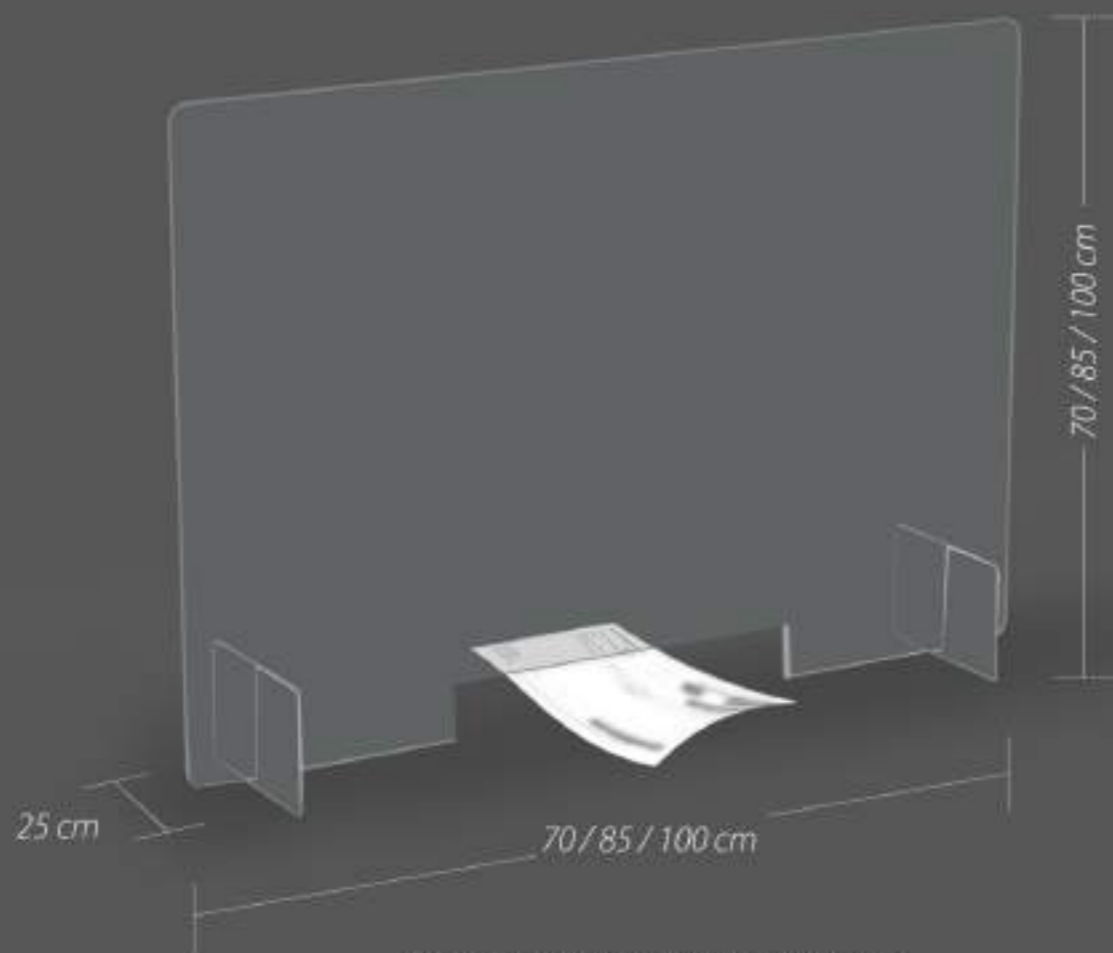

MATERIAL: TRANSPARENT METHACRYLATE
TOTAL WEIGHT: ~3 Kg



ACCESSORY:
SURFACE SANITIZING SPRAY (not included)
Pocket-sized, alcohol-based, fast-acting
How to use: shake the bottle and spray on the surfaces to be treated. It does not require further cleaning with a cloth.
ALL SANITIZING PRODUCTS ARE SOLD SEPARATELY



EXAMPLE OF USE



AVAILABLE SIZES: 85x70 cm - 70x85 cm - 100x70 cm - 70x100 cm
*Customized dimensions on request

10 ADJUSTABLE PROTECTIVE PARTITION

Social distance

The adjustable protective partition is a transparent methacrylate panel with a solid structure. It is easy to position thanks to aluminum blocks with clamp fastening.

The adjustable protective partition can be positioned according to necessity and creating discretion and safety in everyday environments.

Our solution protects against unnecessary contacts and guarantees privacy thanks to the possibility of customized it with the satin effect.

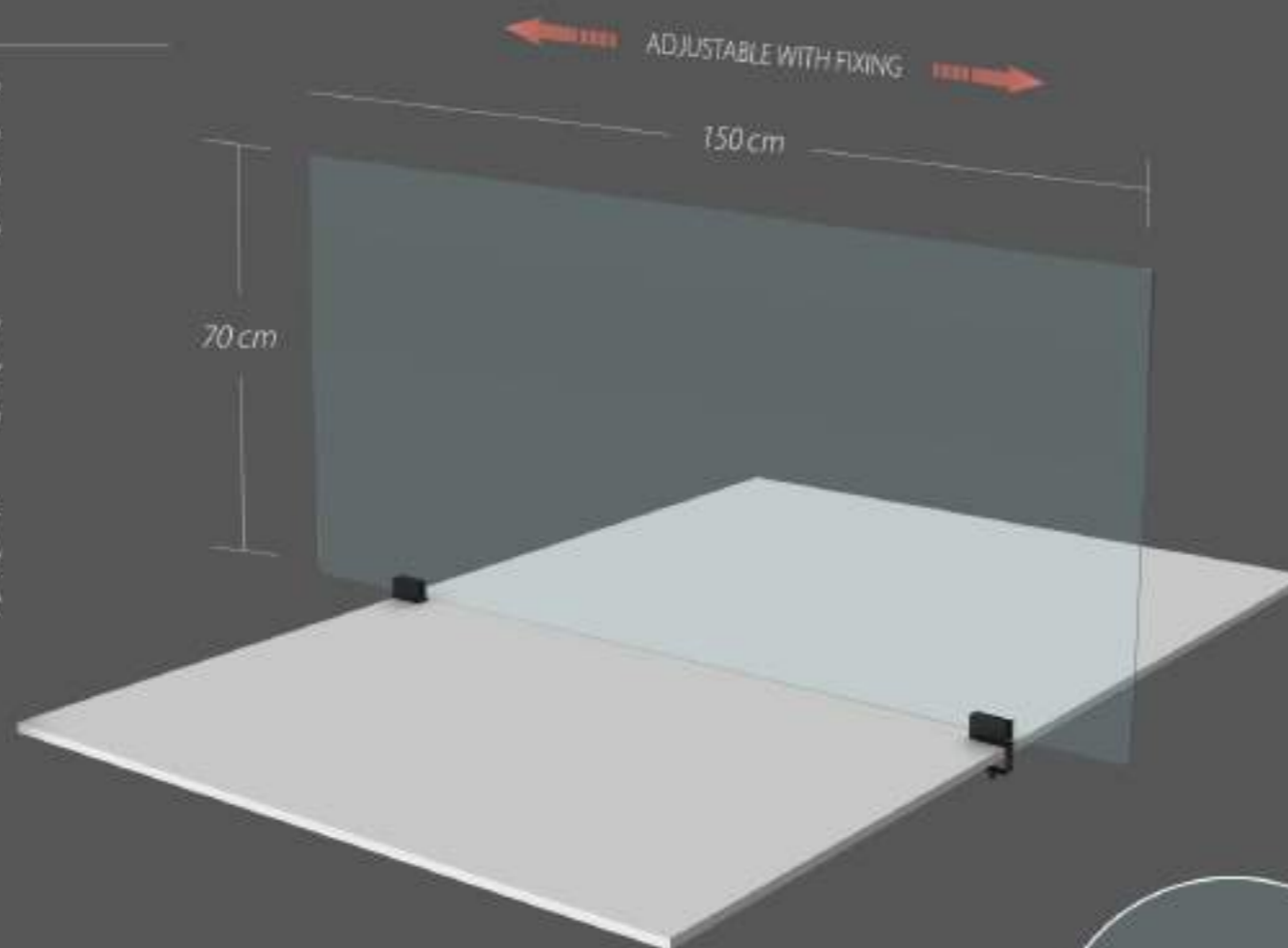

MATERIAL: TRANSPARENT METHACRYLATE AND ALUMINIUM



EXAMPLE OF USE



ACCESSORY:
SURFACE SANITIZING SPRAY (not included)
Pocket-sized, alcohol-based, fast-acting
How to use: shake the bottle and spray on the surfaces to be treated
It does not require further cleaning with a cloth.
ALL SANITIZING PRODUCTS ARE SOLD SEPARATELY



CLAMP FIXING



PANEL ADJUSTMENT



FIXING SYSTEM PANEL

10a ADJUSTABLE PROTECTIVE PARTITION

Social distance

The adjustable protective partition is a transparent methacrylate panel with a solid structure. It is easy to position thanks to aluminum blocks with clamp fastening.

The adjustable protective partition can be positioned according to necessity and creating discretion and safety in everyday environments.

Our solution protects against unnecessary contacts and guarantees privacy thanks to the possibility of customized it with the satin effect.

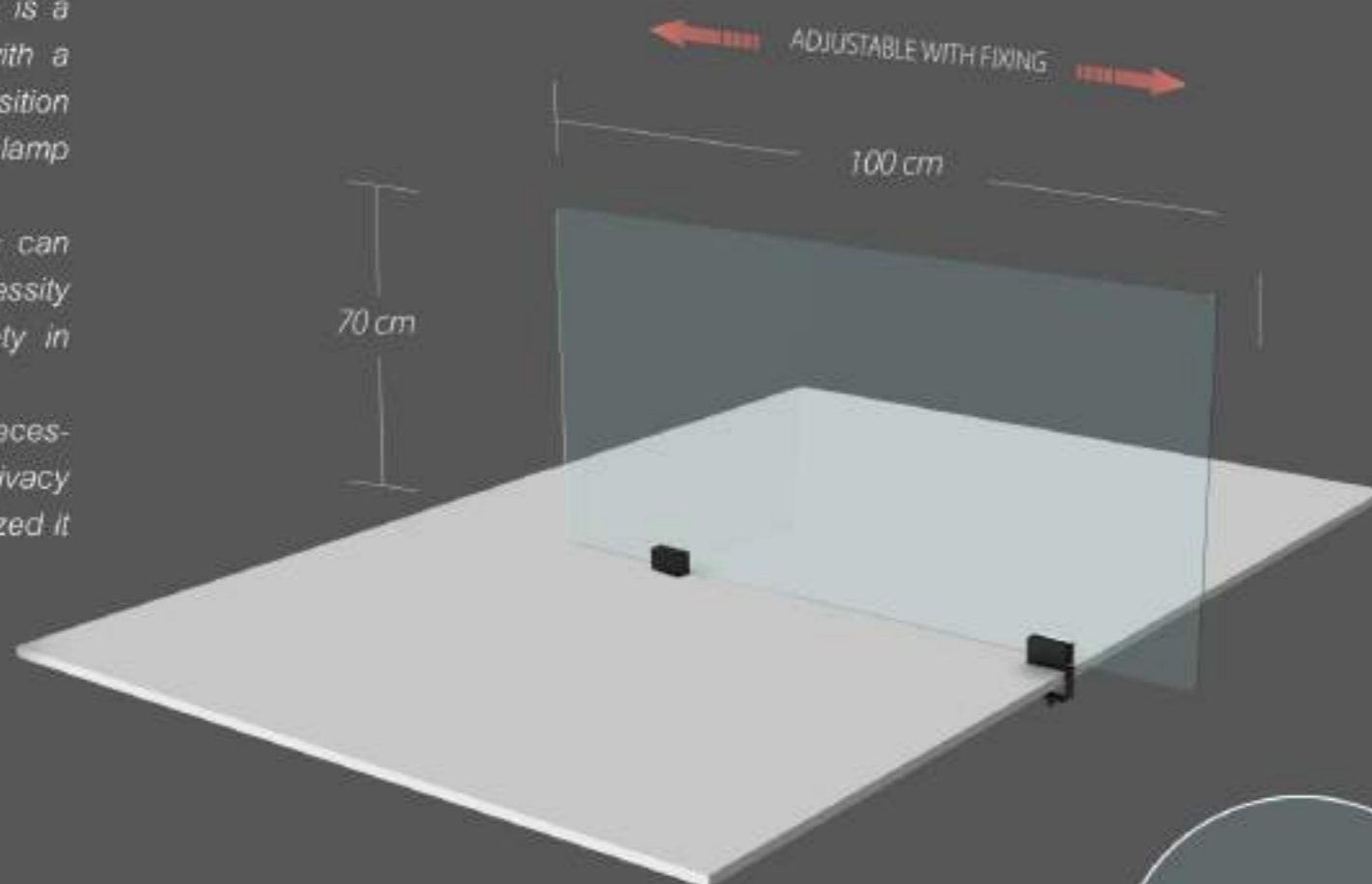

MATERIAL: TRANSPARENT METHACRYLATE AND ALUMINIUM



ACCESSORY:
SURFACE SANITIZING SPRAY (not included)
Pocket-sized, alcohol-based, fast-acting
How to use: shake the bottle and spray on the surfaces to be treated
It does not require further cleaning with a cloth.
ALL SANITIZING PRODUCTS ARE SOLD SEPARATELY



EXAMPLE OF USE



CLAMP FIXING



PANEL ADJUSTMENT



FIXING SYSTEM
PANEL

10b ADJUSTABLE PROTECTIVE PARTITION

Social distance

The adjustable protective partition is a transparent methacrylate panel with a solid structure. It is easy to position thanks to aluminum blocks with clamp fastening.

The adjustable protective partition can be positioned according to necessity and creating discretion and safety in everyday environments.

Our solution protects against unnecessary contacts and guarantees privacy thanks to the possibility of customized it with the satin effect.

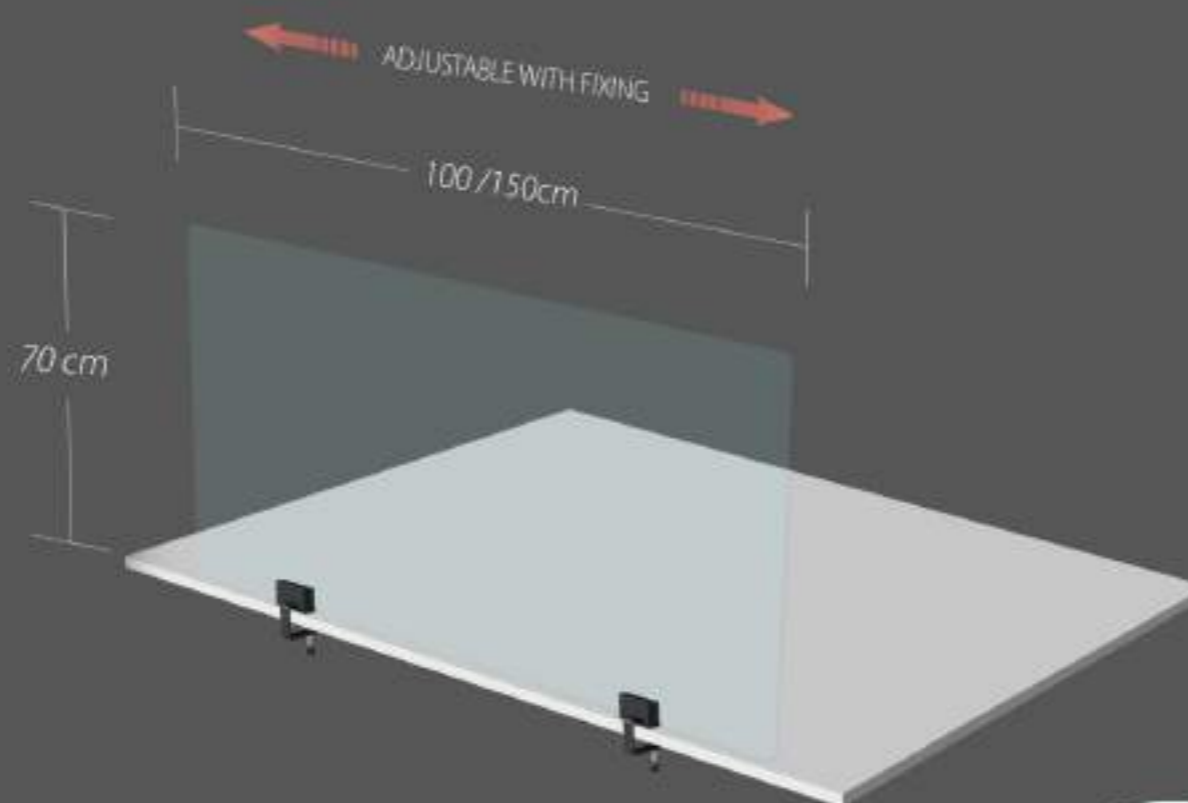

MATERIAL: TRANSPARENT METHACRYLATE AND ALUMINIUM



ACCESSORY:
SURFACE SANITIZING SPRAY (not included)
Pocket-sized, alcohol-based, fast-acting
How to use: shake the bottle and spray on the surfaces to be treated
It does not require further cleaning with a cloth.
ALL SANITIZING PRODUCTS ARE SOLD SEPARATELY



EXAMPLE OF USE



CLAMP FIXING



PANEL ADJUSTMENT



FIXING SYSTEM
PANEL

10c ADJUSTABLE PROTECTIVE PARTITION

Social distance

The adjustable protective partition is a transparent methacrylate panel with a solid structure. It is easy to position thanks to aluminum blocks with clamp fastening.

The adjustable protective partition can be positioned according to necessity and creating discretion and safety in everyday environments.

Our solution protects against unnecessary contacts and guarantees privacy thanks to the possibility of customized it with the satin effect.

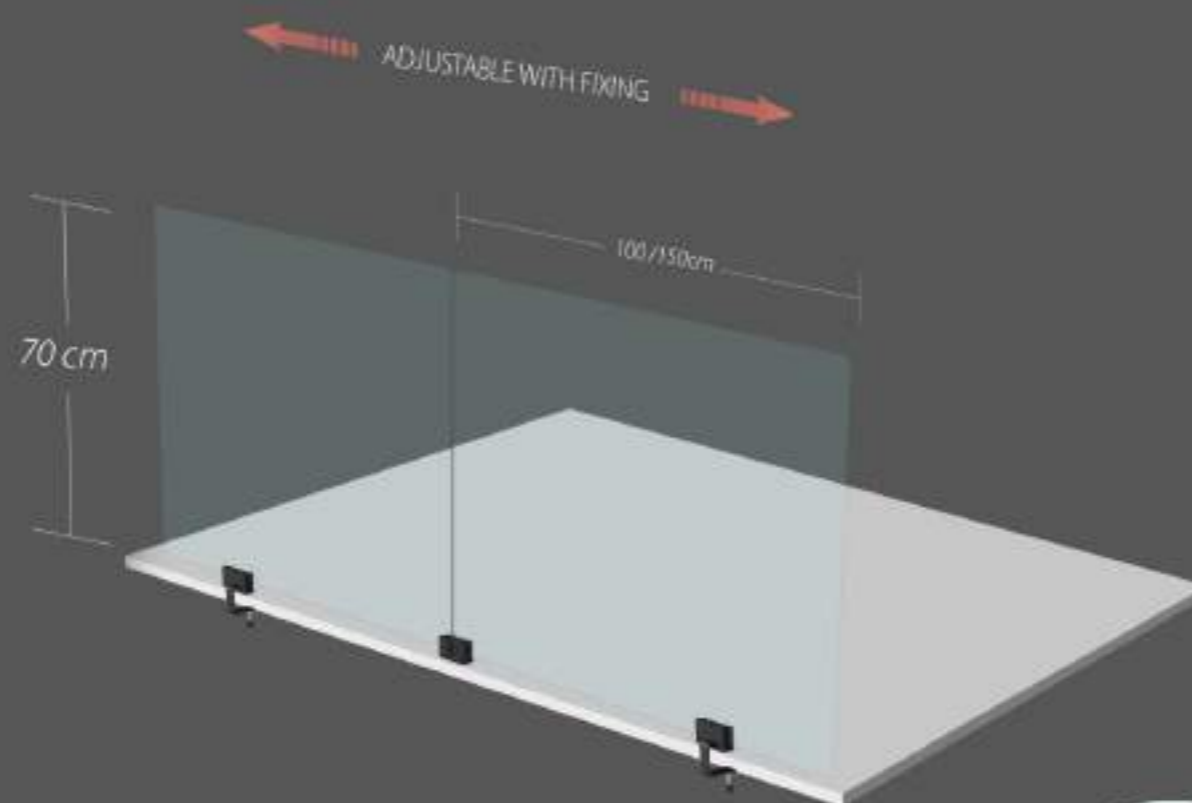

MATERIAL: TRANSPARENT METHACRYLATE AND ALUMINIUM



EXAMPLE OF USE



ACCESSORY:
SURFACE SANITIZING SPRAY (not included)
Pocket-sized, alcohol-based, fast-acting
How to use: shake the bottle and spray on the surfaces to be treated
It does not require further cleaning with a cloth.
ALL SANITIZING PRODUCTS ARE SOLD SEPARATELY



CLAMP FIXING

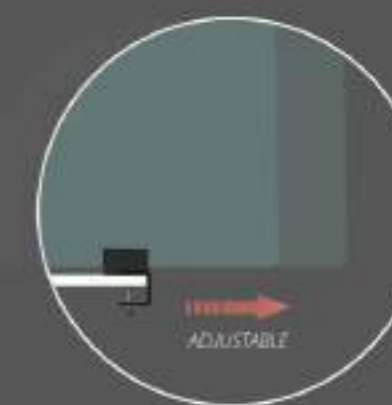

PANEL ADJUSTMENT



FIXING SYSTEM
PANEL

MODULAR PROTECTIVE PARTITION

Social distance



CLAMP
lateral position
(clamping system)



CLAMP
frontal position
(clamping system)



CLAMP
lateral position
(clamping system with adhesive or with felt pad)

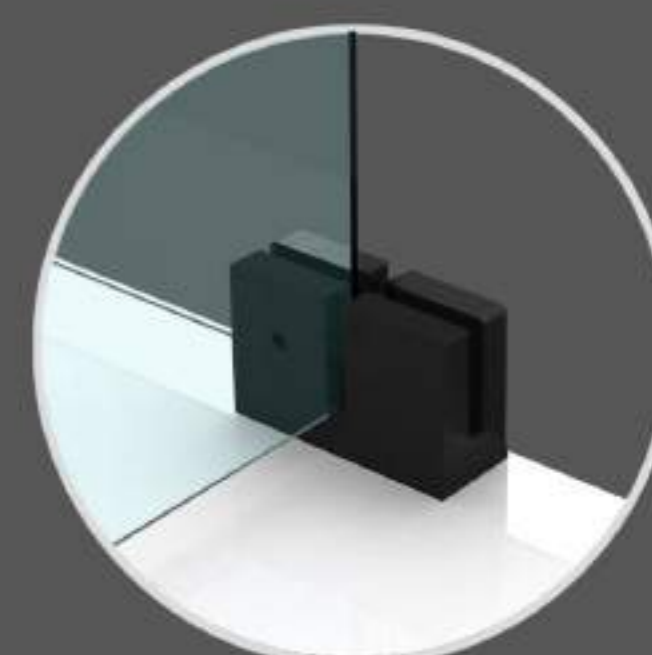

CLAMP
frontal position
(clamping system with adhesive or with felt pad)

MODULAR PROTECTIVE PARTITION - EXAMPLES

Social distance

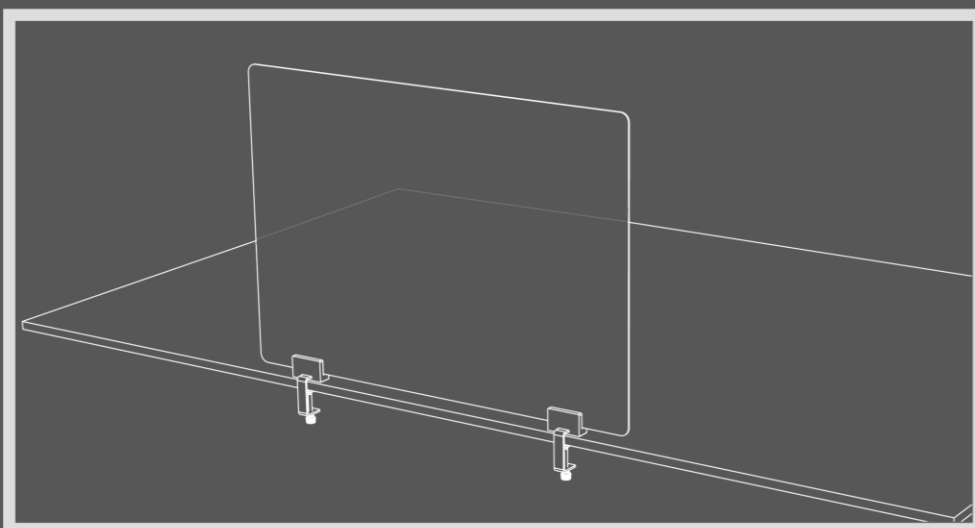

EXAMPLE OF USE 1

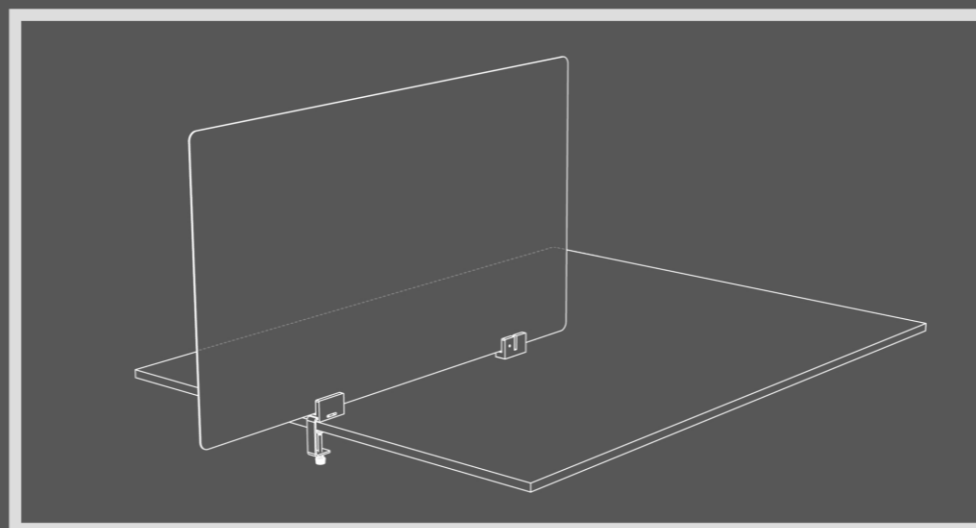

EXAMPLE OF USE 2

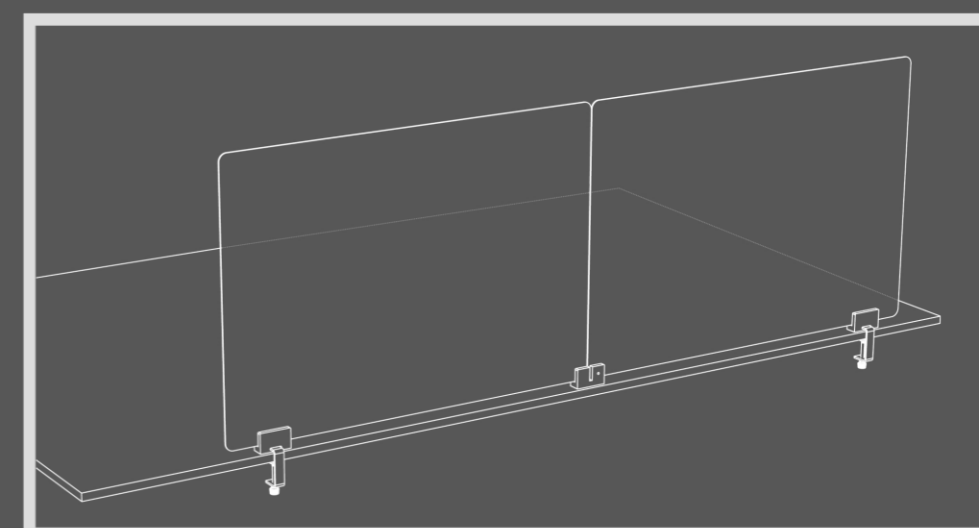

EXAMPLE OF USE 3

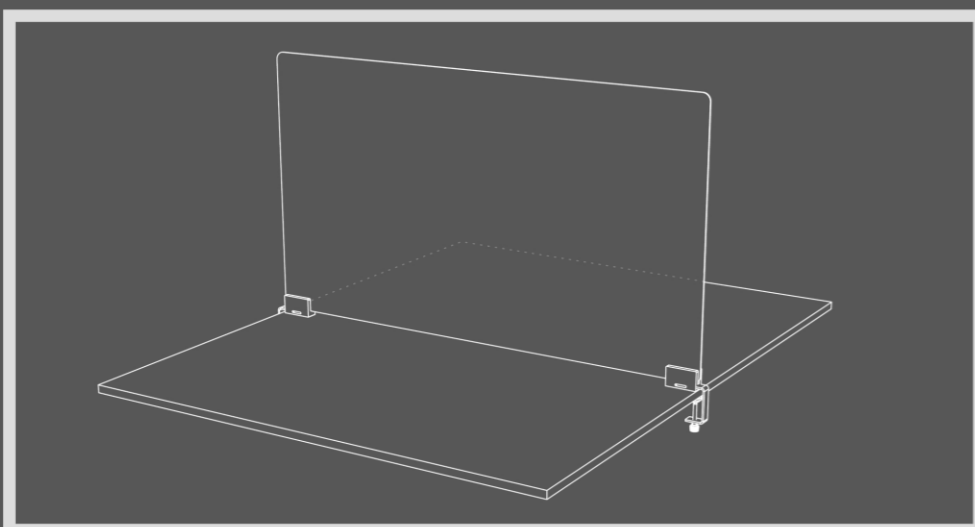

EXAMPLE OF USE 4

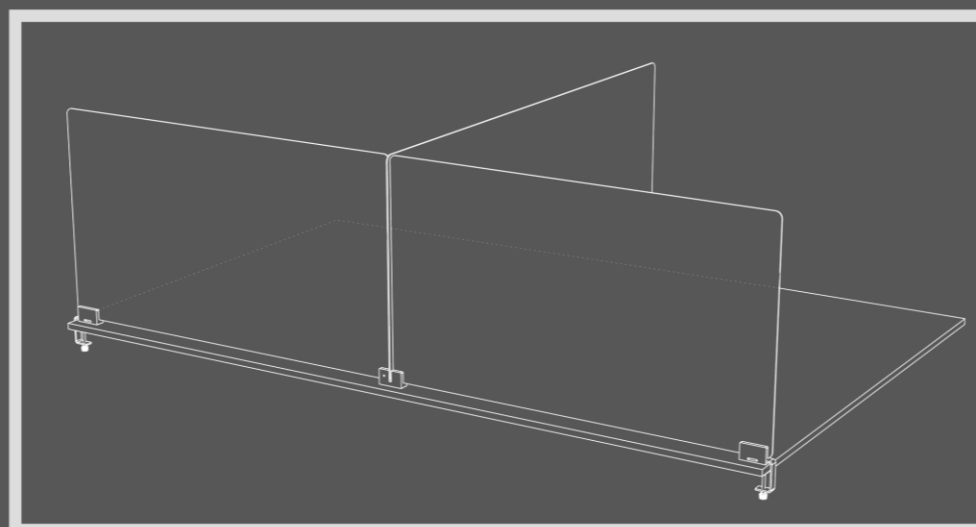

EXAMPLE OF USE 5

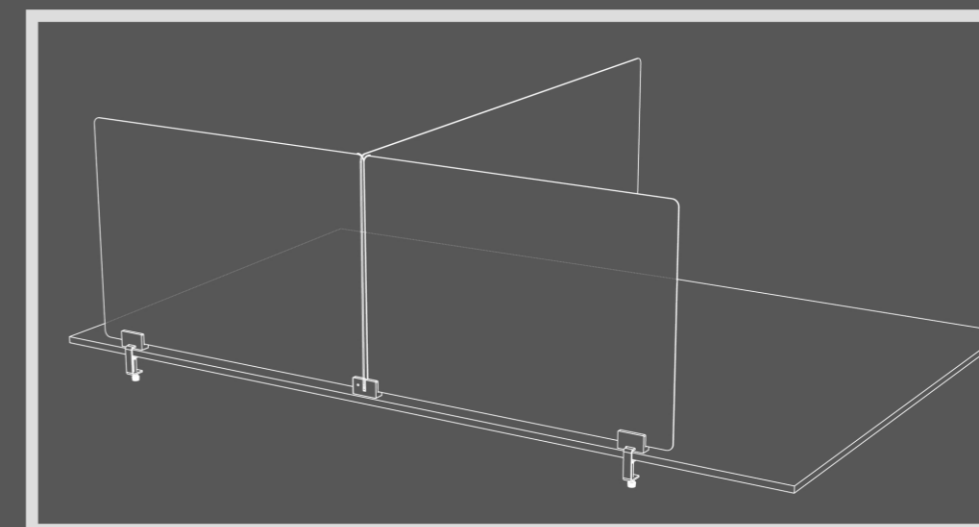

EXAMPLE OF USE 6

15 PROTECTIVE PARTITION

Social distance

The protective partition is a transparent methacrylate panel which, thanks to the presence of aluminum blocks with clamp fastening, becomes a solid structure and easy to position. It is suitable to create discretion and safety in everyday environments. The system, specially designed to maintain the correct safety distances, is ideal as a partition for desks and workstations.

It consists of a transparent PMMA panel with dimensions 85x70 cm or 100x70 cm and a vertical support that keeps it in position thanks to the two vertically adjustable clamps. Everything is fixed to the shelf by means the use of clamps that allow easy installation of the partition.

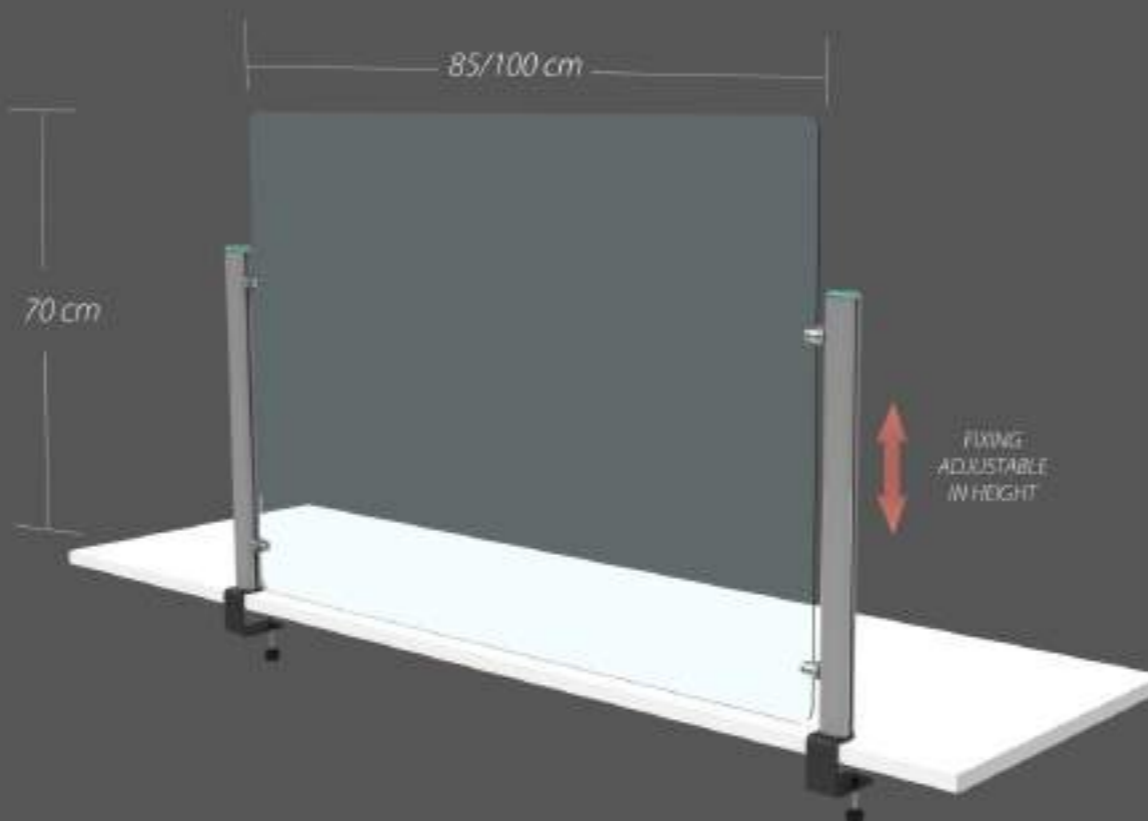

MATERIAL: TRANSPARENT METHACRYLATE, ALUMINIUM PROFILE AND CLAMPS



EXAMPLE OF USE



ACCESSORY:
SURFACE SANITIZING SPRAY (not included)
Pocket-sized, alcohol-based, fast-acting
How to use: shake the bottle and spray on the surfaces to be treated
It does not require further cleaning with a cloth.
ALL SANITIZING PRODUCTS ARE SOLD SEPARATELY



CLAMP FIXING



HEIGHT ADJUSTMENT

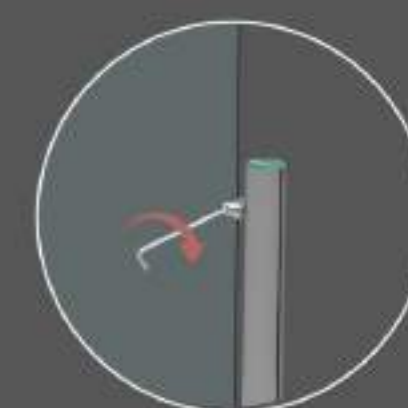

FIXING SYSTEM
PANEL

16 PROTECTIVE PARTITION

Social distance

The protective partition is a transparent methacrylate panel which, thanks to the presence of aluminum blocks with clamp fastening, becomes a solid structure and easy to position. It is suitable to create discretion and safety in everyday environments. The system, specially designed to maintain the correct safety distances, is ideal as a partition for desks and workstations. In the modular version, it is possible to place several panels in order to cover longer workstations. Everything is fixed to the shelf by means the use of clamps that allow easy installation of the partition.

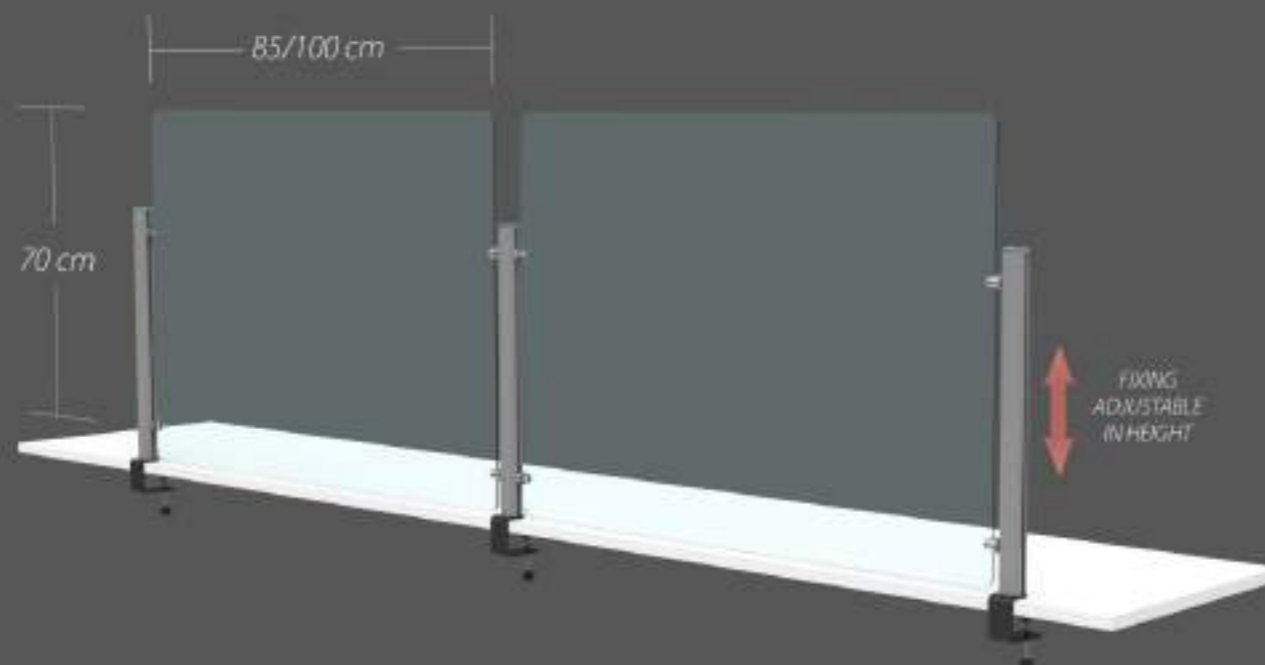

MATERIAL: TRANSPARENT METHACRYLATE, ALUMINIUM PROFILE AND CLAMPS



EXAMPLE OF USE



ACCESSORY:
SURFACE SANITIZING SPRAY (not included)
Pocket-sized, alcohol-based, fast-acting
How to use: shake the bottle and spray on the surfaces to be treated
It does not require further cleaning with a cloth.
ALL SANITIZING PRODUCTS ARE SOLD SEPARATELY



CLAMP FIXING



HEIGHT ADJUSTMENT

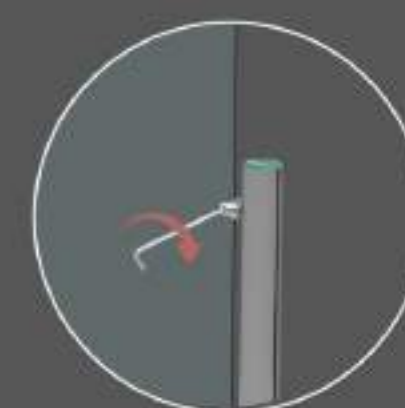

FIXING SYSTEM
PANEL

MODULAR PROTECTIVE PARTITION

Social distance

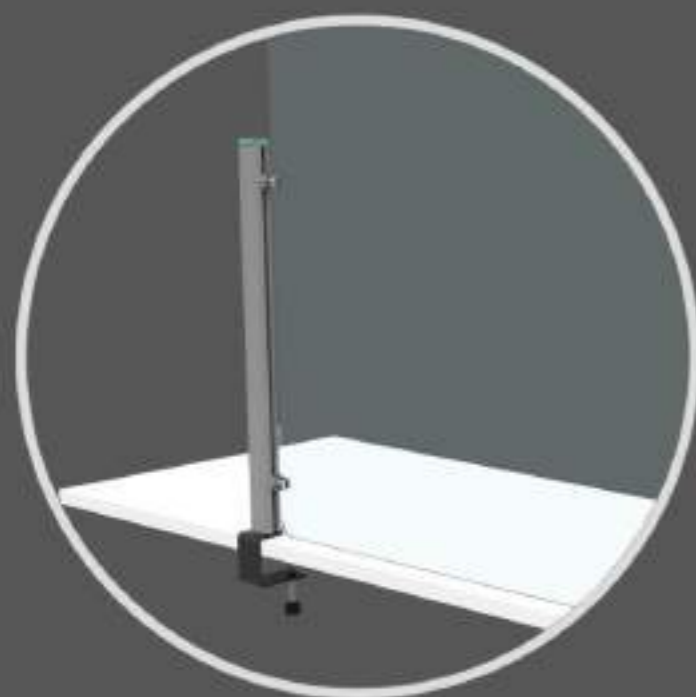

CLAMP
(clamping system)



CLAMP
(clamping system)

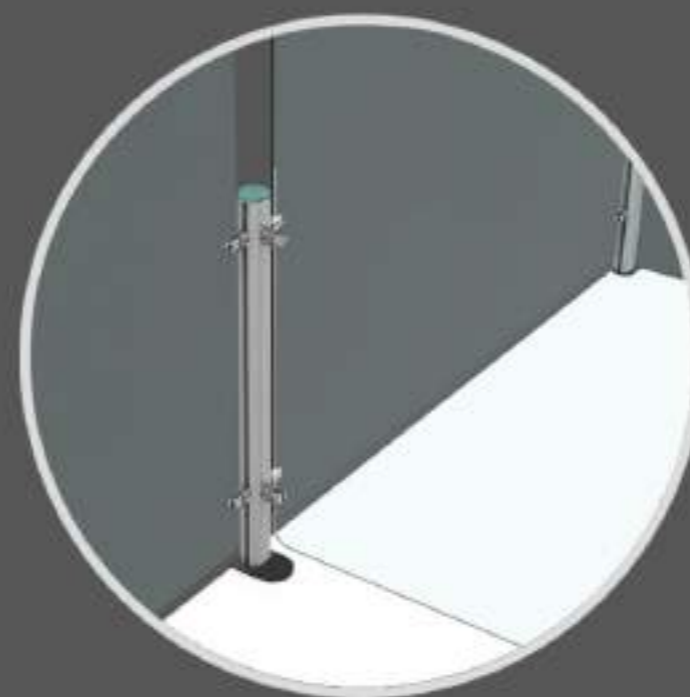

CLAMP
(clamping system)

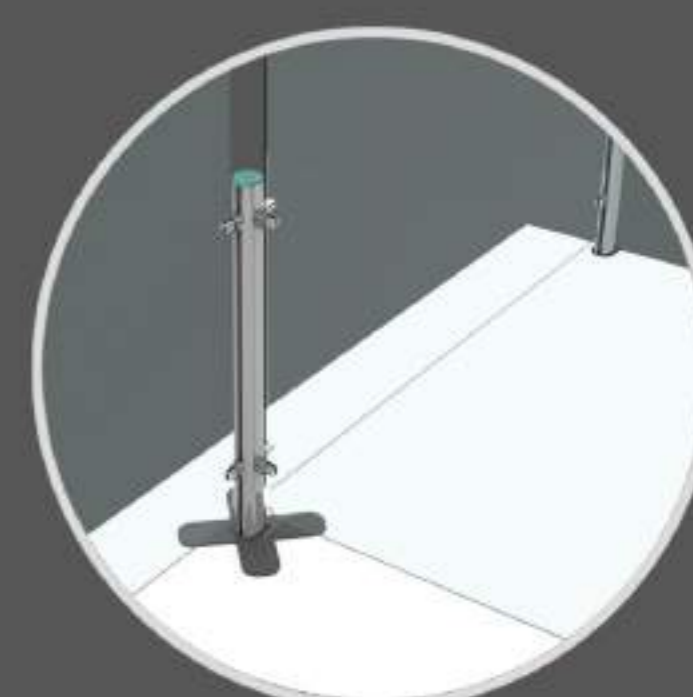

SUPPORT
(fixing with support foot)

MODULAR PROTECTIVE PARTITION - EXAMPLES

Social distance

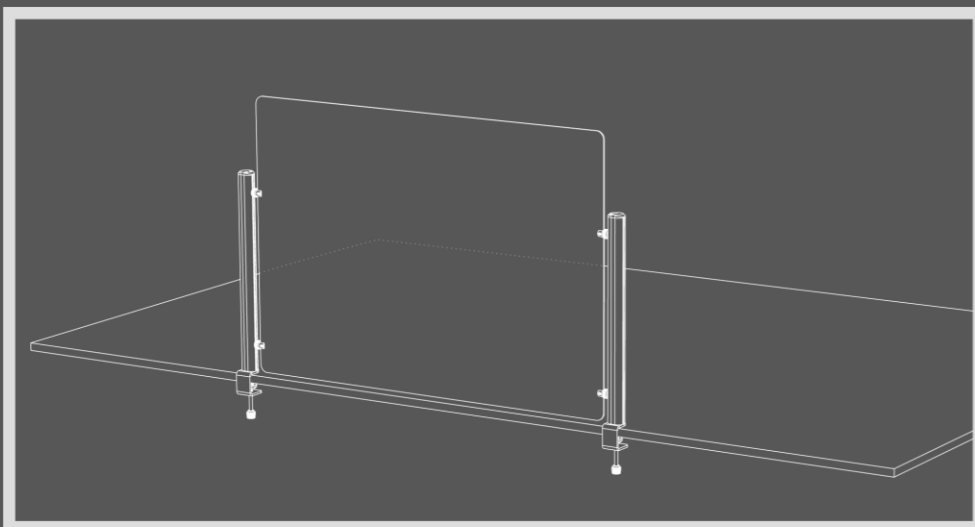

EXAMPLE OF USE 1

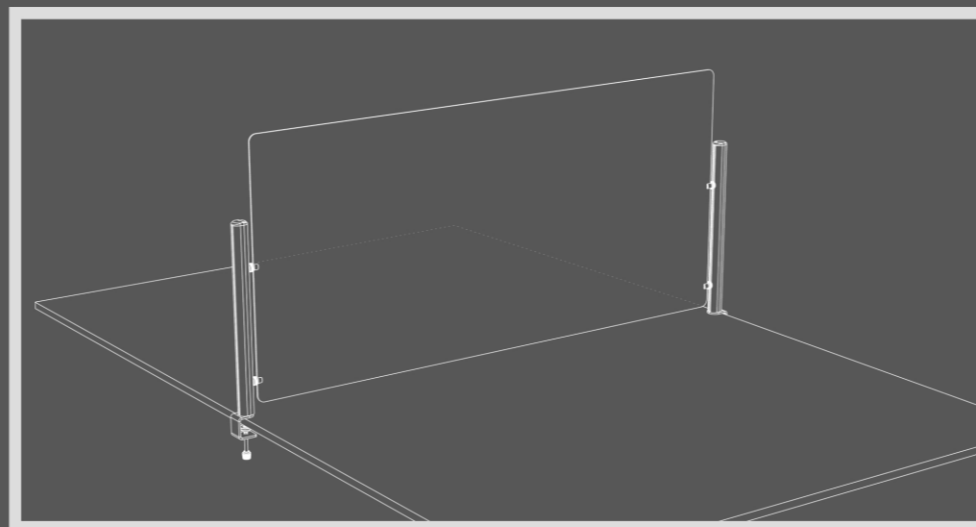

EXAMPLE OF USE 2

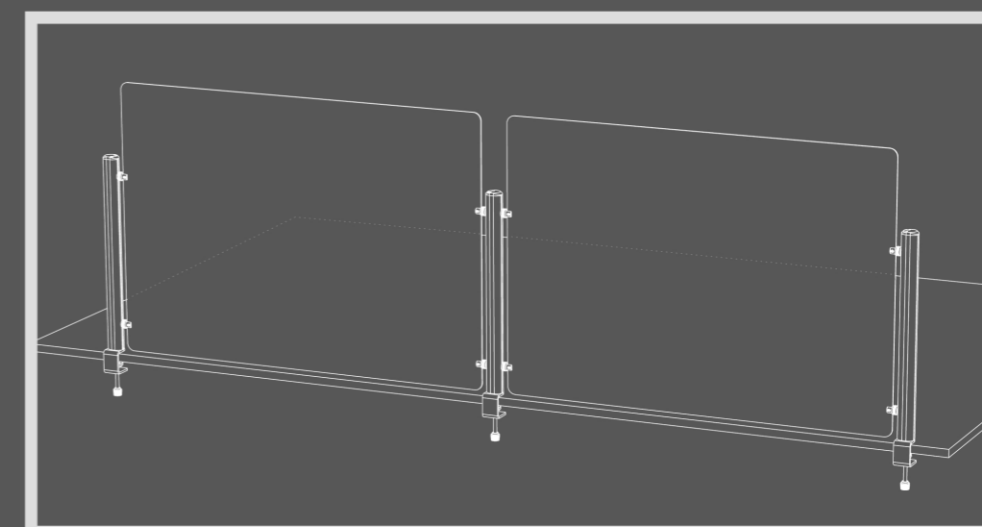

EXAMPLE OF USE 3

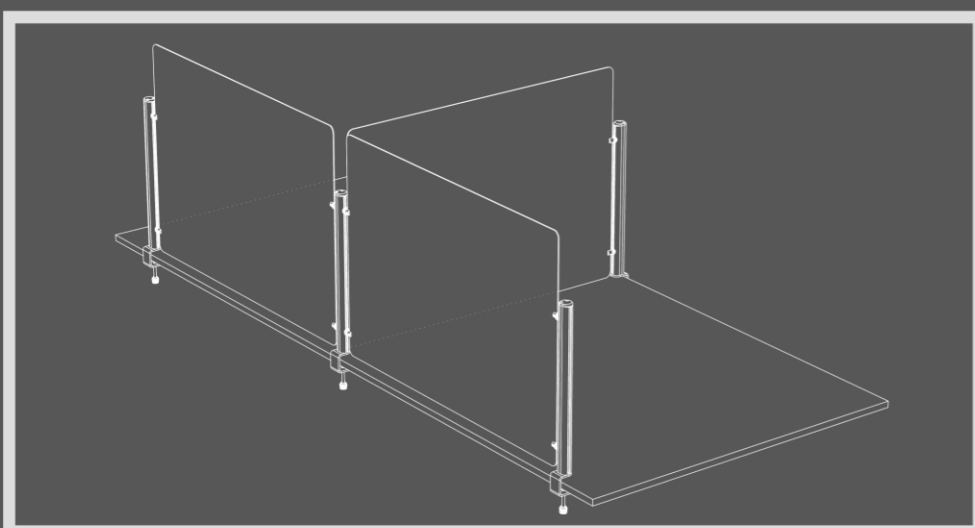

EXAMPLE OF USE 4

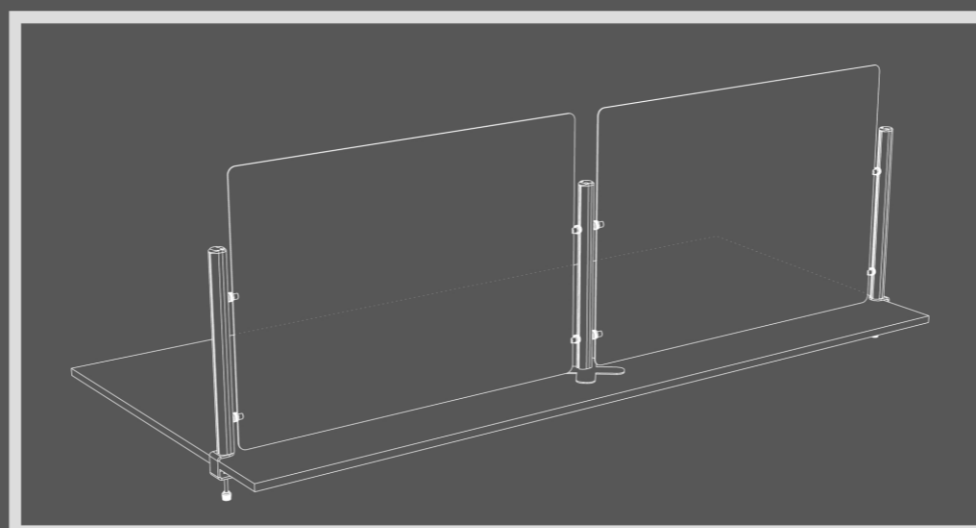

EXAMPLE OF USE 5

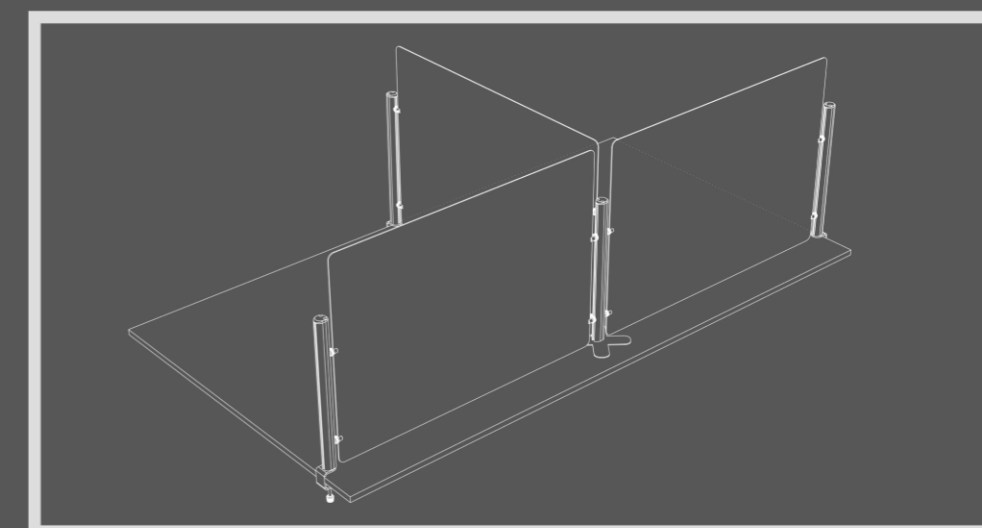

EXAMPLE OF USE 6







3 MOBILFLEX - FREESTANDING PROTECTIVE PARTITION

Social distance

MobilFlex is our freestanding and dynamic protective wall designed to divide areas both indoor and outdoor of your environments and allows you to guarantee the recommended distances. Mobilflex is an aluminum structure with polycarbonate details, equipped with swivel wheels which make transport of the structure quick and easy. Mobilflex has a light and refined design and his structure is space-saving and perfectly adaptable to any context.

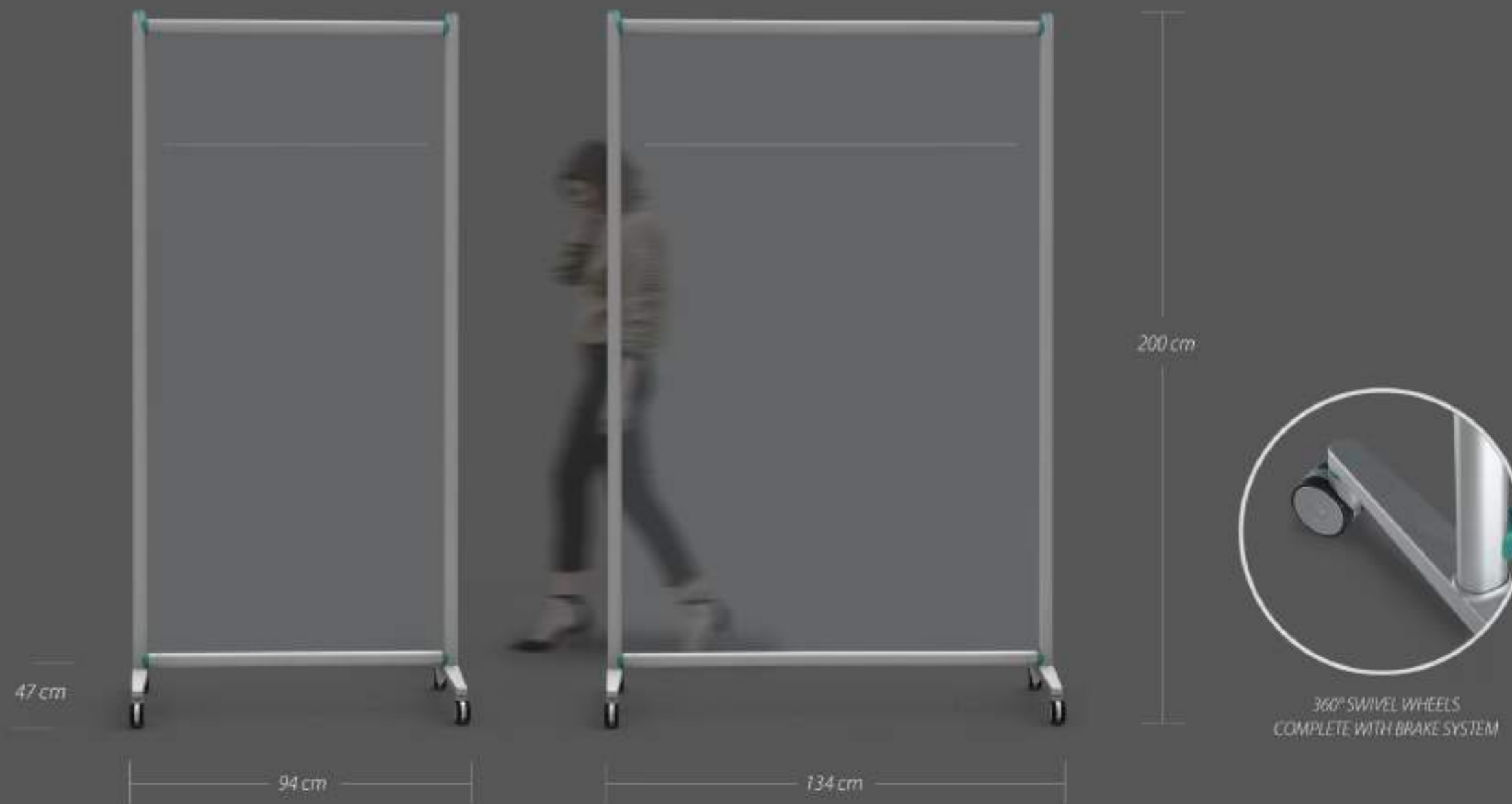

ACCESSORY:
SURFACE SANITIZING SPRAY (not included)
 Pocket-sized, alcohol-based, fast-acting
 How to use: shake the bottle and spray on the surfaces to be treated
 It does not require further cleaning with a cloth.
ALL SANITIZING PRODUCTS ARE SOLD SEPARATELY

MATERIAL: TRANSPARENT METHACRYLATE AND ANODIZED ALUMINUM PROFILES

3 MOBILFLEX - FREESTANDING PROTECTIVE PARTITION

Social distance



INDOOR & OUTDOOR

MobilFlex is the perfect solution to create comfortable reserved areas inside and outside your rooms. Mobilflex guarantees safe areas and gives dynamism according to the needs of use. Cleaning of the structure is quick and easy.



3 MOBILFLEX - FREESTANDING PROTECTIVE PARTITION

Social distance



EXAMPLE OF USE

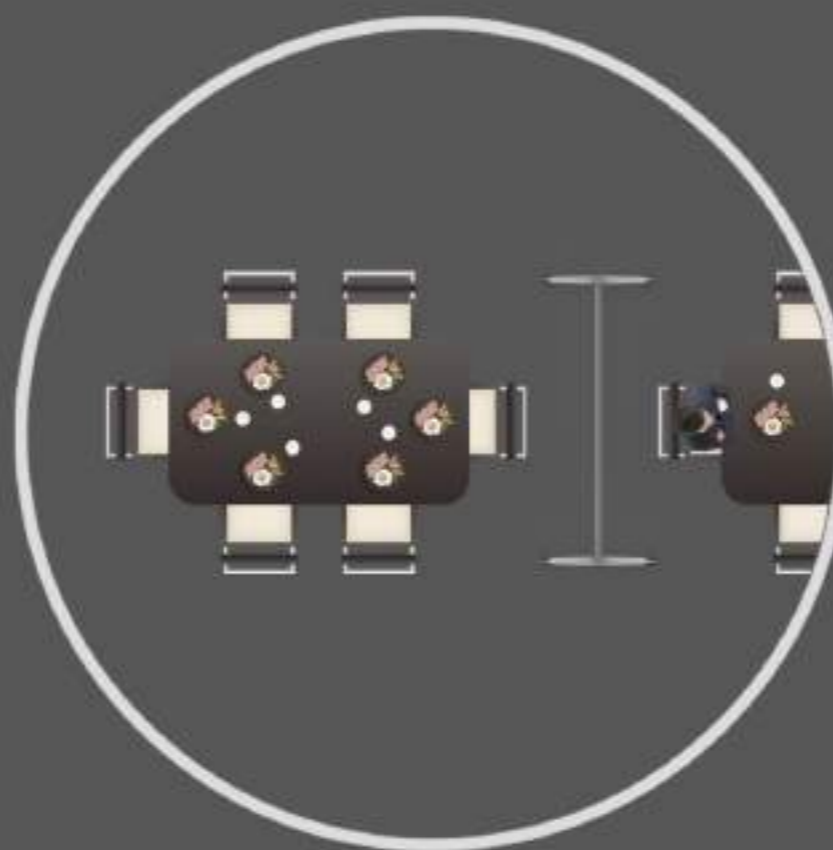

EXAMPLE OF USE



EXAMPLE OF USE

3 MOBILFLEX - MODULAR FREESTANDING PROTECTIVE PARTITION

Social distance

MobilFlex is available as modular version. It is a freestanding protective wall with wheels which allows you to create compositions with other protective walls hooked by means of hinges. Practical and simple, MobilFlex is perfect to protect customers and operators from unnecessary direct contacts.

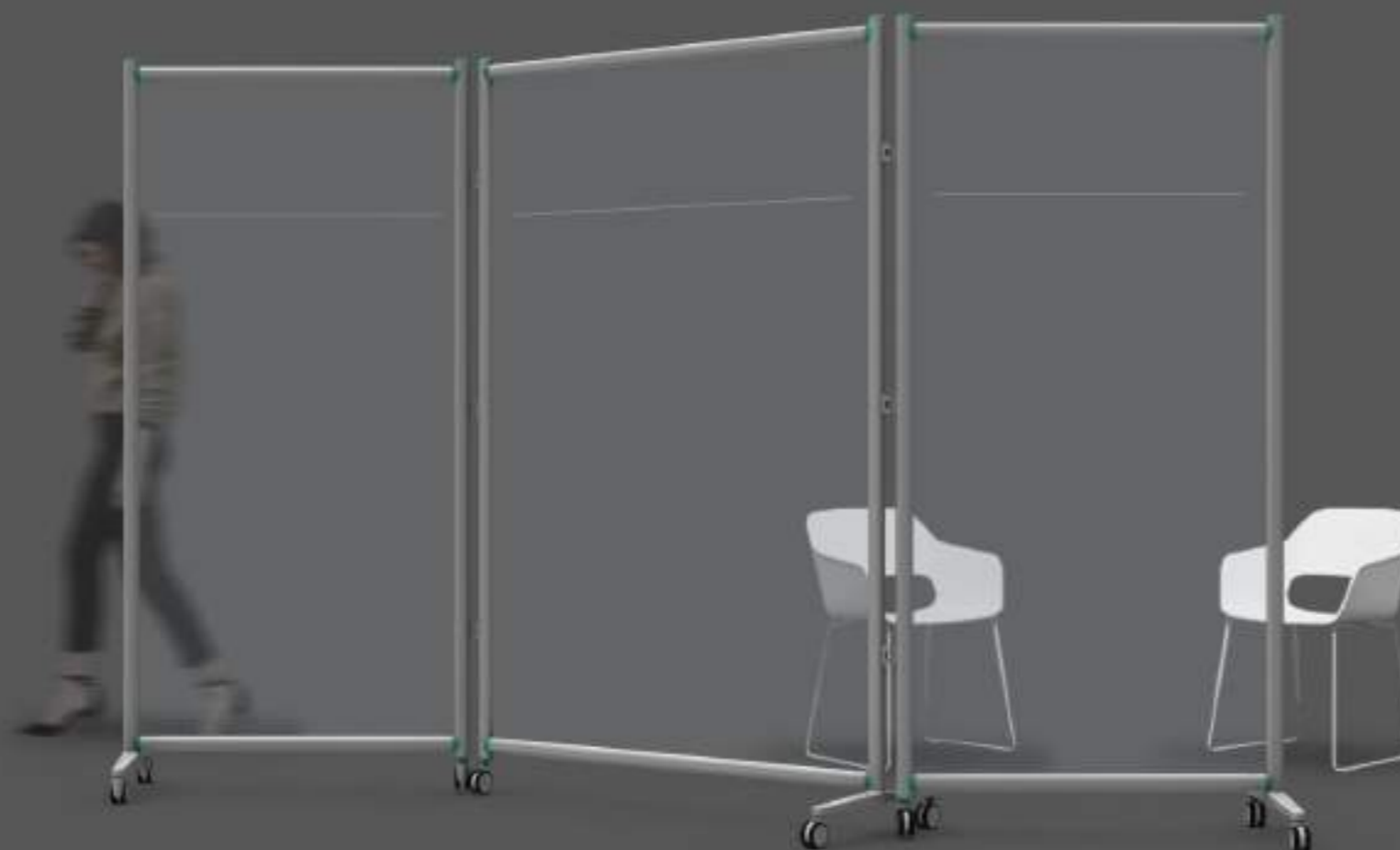

DOOR DIMENSIONS



ACCESSORY:
SURFACE SANITIZING SPRAY (not included)
 Pocket-sized, alcohol-based, fast-acting
 How to use: shake the bottle and spray on the surfaces to be treated
 It does not require further cleaning with a cloth.
ALL SANITIZING PRODUCTS ARE SOLD SEPARATELY

MATERIAL: TRANSPARENT METHACRYLATE AND ANODIZED ALUMINUM PROFILES

3 MOBILFLEX - MODULAR FREESTANDING PROTECTIVE PARTITION

Social distance



MobilFlex makes the management of your business more flexible and efficient. Created in perfect Flex style, it guarantees a slim and elegant design, the MobilFlex freestanding protective wall is perfect for your indoor and outdoor environments.

INDOOR & OUTDOOR

3 MOBILFLEX - MODULAR FREESTANDING PROTECTIVE PARTITION

Social distance



EXAMPLE OF USE



EXAMPLE OF USE

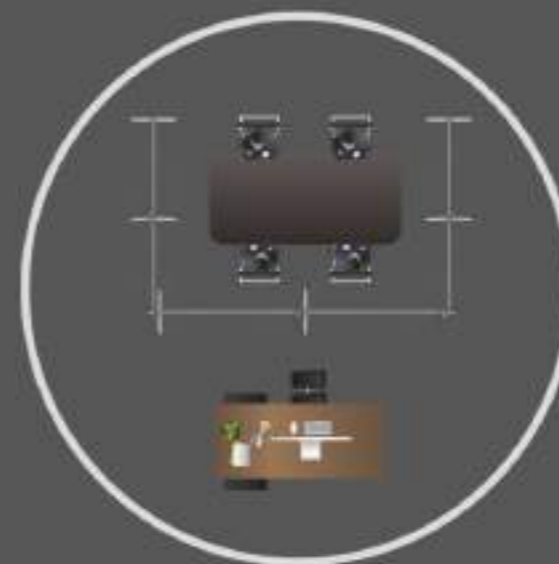

EXAMPLE OF USE

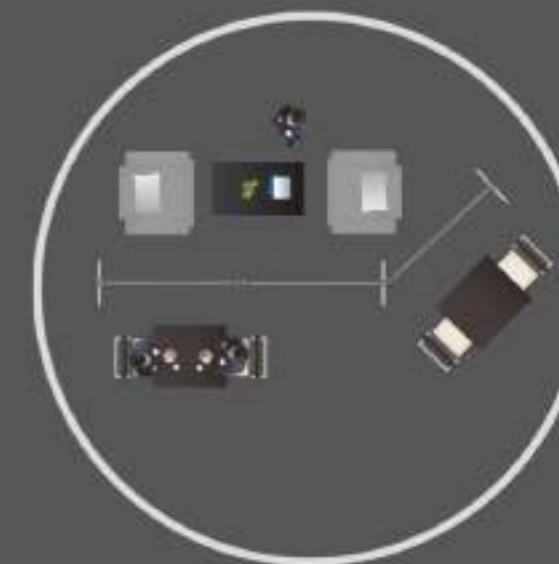

EXAMPLE OF USE

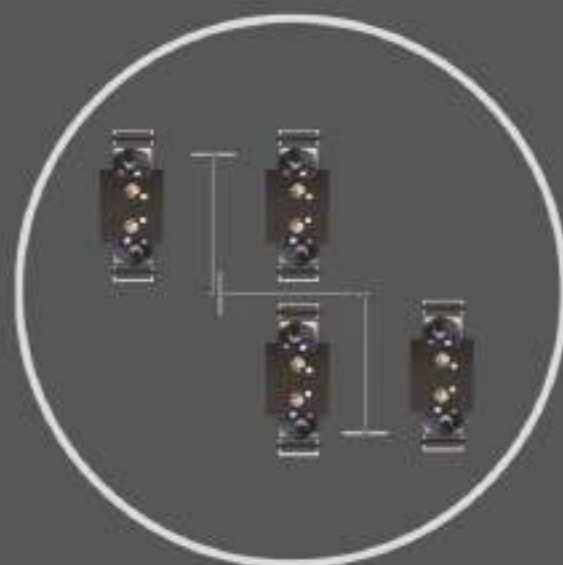

EXAMPLE OF USE

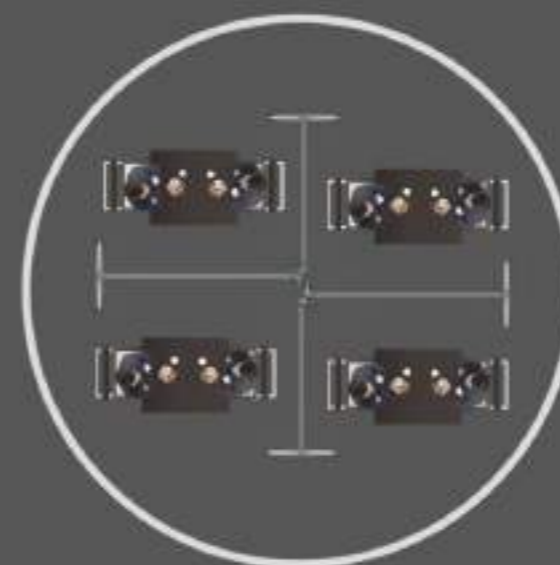

EXAMPLE OF USE

3 MOBILFLEX - FREESTANDING PROTECTIVE PARTITION

Social distance

MobilFlex is also available in the version with an opening which allows the passage of documents and, if necessary, can be integrated with a shelf, useful to support the products necessary for sanitizing operations. With a simple and elegant design, the version with shelf becomes a functional element that adapts perfectly to all contexts, integrating harmoniously with everything that surrounds it.



CENTRAL SLOT CREATED FOR THE PASSAGE OF DOCUMENTS.

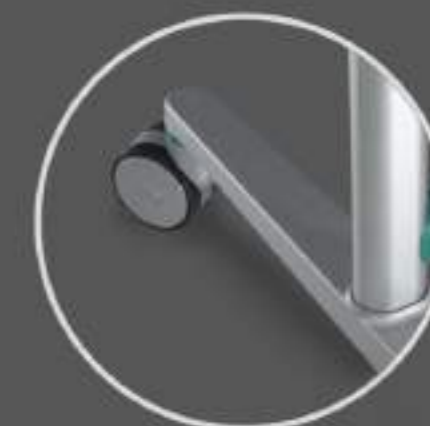

360° SWIVEL WHEELS COMPLETE WITH BRAKE SYSTEM.



ACCESSORY:
SURFACE SANITIZING SPRAY (not included)
Pocket-sized, alcohol-based, fast-acting
How to use: shake the bottle and spray on the surfaces to be treated
It does not require further cleaning with a cloth.
ALL SANITIZING PRODUCTS ARE SOLD SEPARATELY

MATERIAL: TRANSPARENT METHACRYLATE AND ANODIZED ALUMINUM PROFILES

MOBILFLEX - CUSTOMIZABLE SELF-SUPPORTING PROTECTIVE WALL

Social distance

MobilFlex has been designed for a creative function. It is possible to write on the protective wall a message to communicate to customers or collaborators, with the help of erasable markers, easily available on the market. To make the rooms private, it is possible to choose the customization in methacrylate with a satin effect.

An important message, the phrase of the day, the menu or simply a note... Details make the difference and Flex aims to make its products unique and performant.



SATIN EFFECT CUSTOMIZATION



WRITABLE MATERIAL WITH ERASABLE MARKERS



3a FREESTANDING PROTECTIVE PARTITION

Social distance

The Flex protective partition freestanding is a new product from the Flex family which, suitably positioned, helps protect workers and the public from direct contact. The protective partition Flex is equipped with a lower slot created for the passage of tools useful for cleaning the floor. It is a solution in transparent methacrylate which is suitable for the environments in which it is inserted. Its standard dimensions are 75 cm and 100 cm in base and 180 in height and it has been designed to protect the customer and the operator, respecting the distance established by law.

The product has a thickness of 10 mm and is equipped with two pedestals and a polyethylene support which make it stable and antistatic.



ACCESSORY:
SURFACE SANITIZING SPRAY (not included)
Pocket-sized, alcohol-based, fast-acting
How to use: shake the bottle and spray on the surfaces to be treated
It does not require further cleaning with a cloth.
ALL SANITIZING PRODUCTS ARE SOLD SEPARATELY

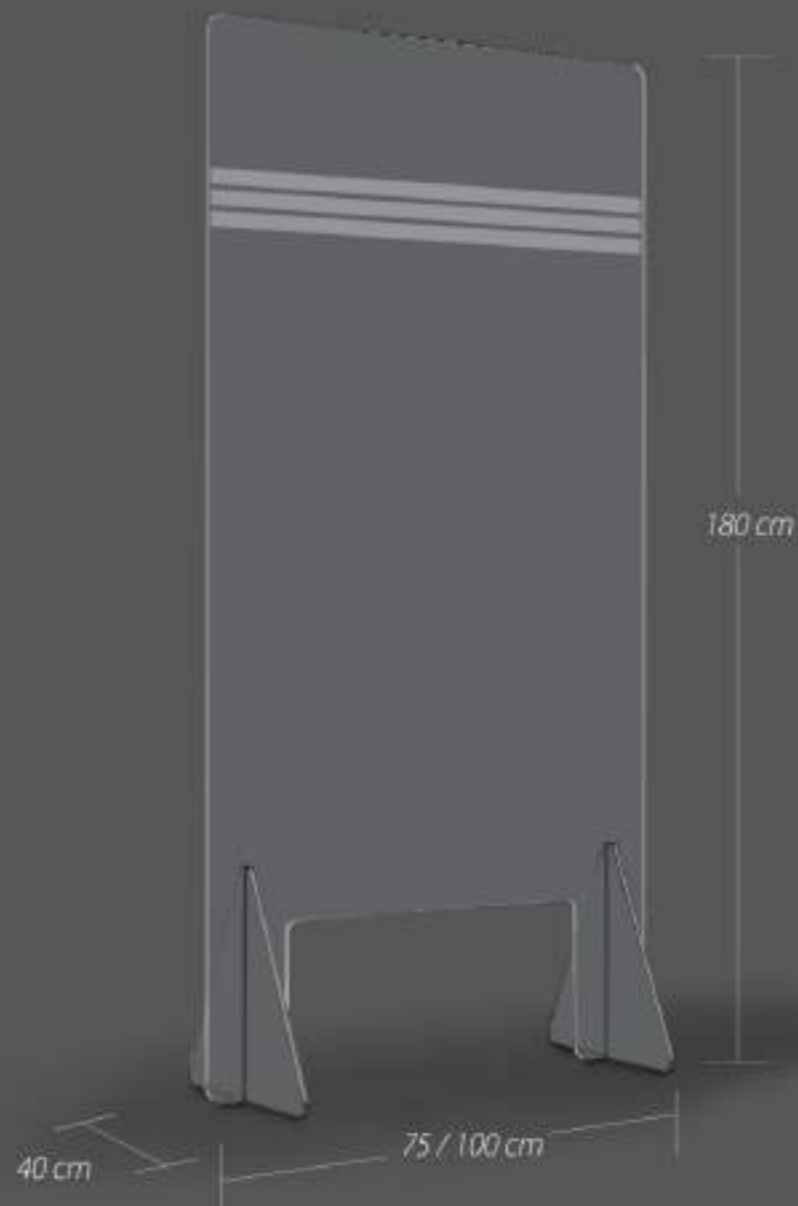

MATERIAL: TRANSPARENT METHACRYLATE AND POLITENE BASES



EXAMPLE OF USE



EXAMPLE OF USE

Lower slot created for the passage of tools useful for cleaning the floor.
Polythene pedestals that make the partition antistatic.



4 THE FREESTANDING PROTECTIVE WALL

Social distance

The FREESTANDING PROTECTIVE WALL, available in the version with wheels for greater ease of transport or in the version without wheels for static workstations, is ideal for environments where pedestrian flow is heavy. It has an opening that allows the passage of documents and can be integrated with a shelf, useful for supporting any product necessary to sanitize. With a simple and elegant design, the FREESTANDING PROTECTIVE WALL adapts perfectly to all contexts, integrating harmoniously with everything that surrounds it.

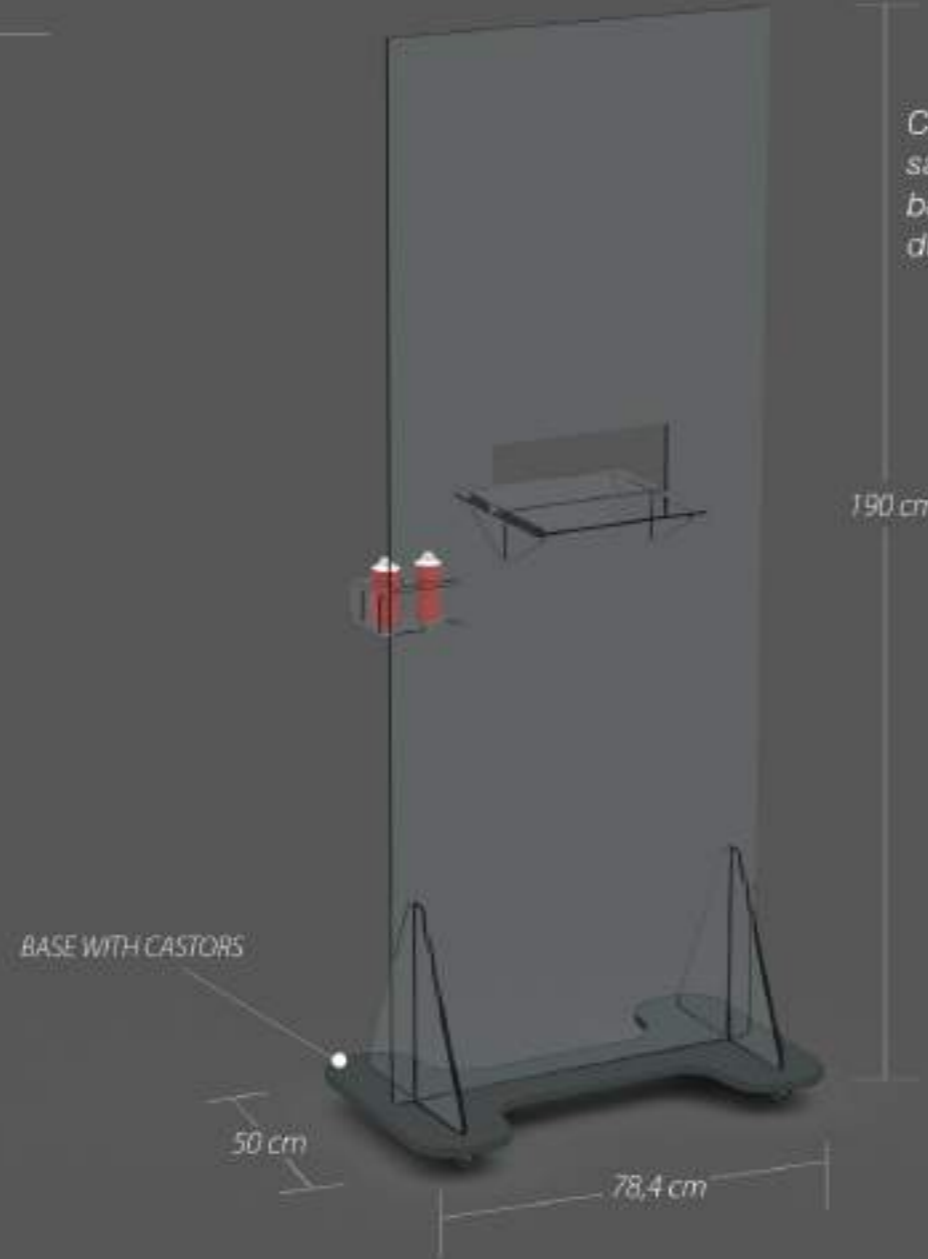

Central slot created for the passage of documents. Polyethylene base which makes it antistatic to dust.



EXAMPLE OF USE



ACCESSORY:
SURFACE SANITIZING SPRAY (not included)
Pocket-sized, alcohol-based, fast-acting
How to use: shake the bottle and spray on the surfaces to be treated. It does not require further cleaning with a cloth.
ALL SANITIZING PRODUCTS ARE SOLD SEPARATELY

MATERIAL: TRANSPARENT METHACRYLATE AND POLITENE BASES
TOTAL WEIGHT : 24 Kg

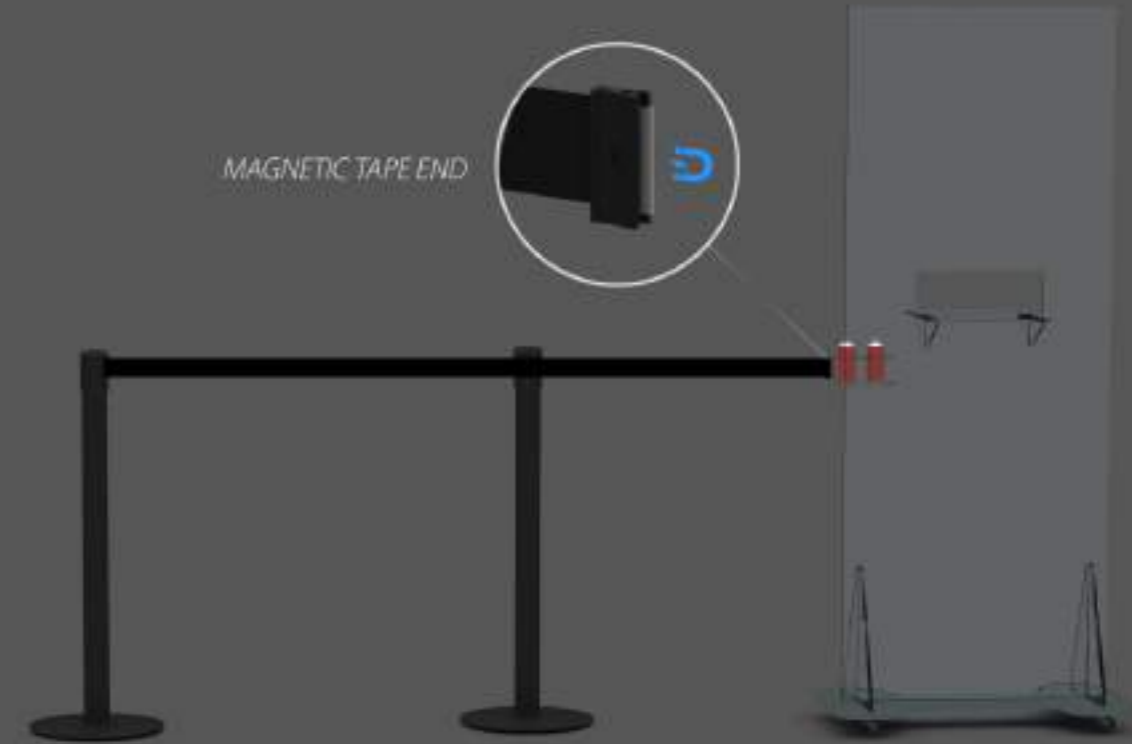

4 FREESTANDING PROTECTIVE PARTITION

Social distance



Version with wheels



Version without wheels



Central slot created for the passage of documents.

14 PROTECTIVE PARTITION - ALLFLEX

Social distnace

The AllFlex protective partition is a product made of transparent methacrylate and suspended on cables fixed both to the ceiling and to the desk. The panel is easily removable to allow sanitization operations that protect operators and customers. It has been specifically designed for front office desks. It guarantees continuous protection and it can be perfectly integrated with the environment.



Installation of two 93x80 cm methacrylate panels.



ACCESSORY:
SURFACE SANITIZING SPRAY (not included)
Pocket-sized, alcohol-based, fast-acting
How to use: shake the bottle and spray on the surfaces to be treated. It does not require further cleaning with a cloth.
ALL SANITIZING PRODUCTS ARE SOLD SEPARATELY

**MATERIAL: TRANSPARENT METHACRYLATE AND BRASS TENSIONERS
WITH POLISHED CHROME FINISH WITH STEEL CABLE**

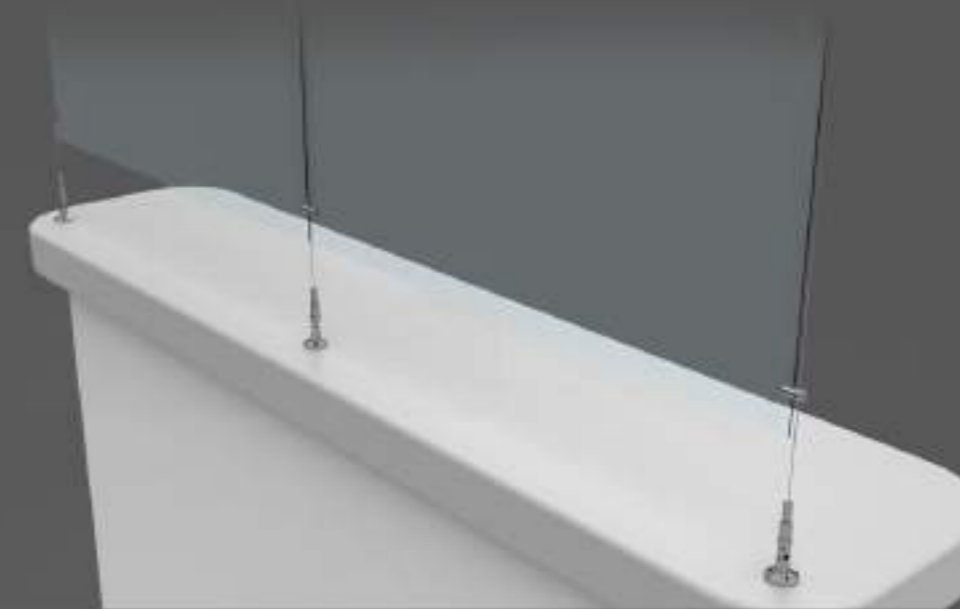

13 ELASTIC TAPE - NO SITTING

Social distance

The Elastic Tape for "do not use seat" is ideal for places where the pedestrian flows are high. It is a tape created with elastic material and equipped with buckles that allows a quick hooking of the product. The colors available are purple, burgundy, blue, green and yellow but the customization with colors and company logos is possible.

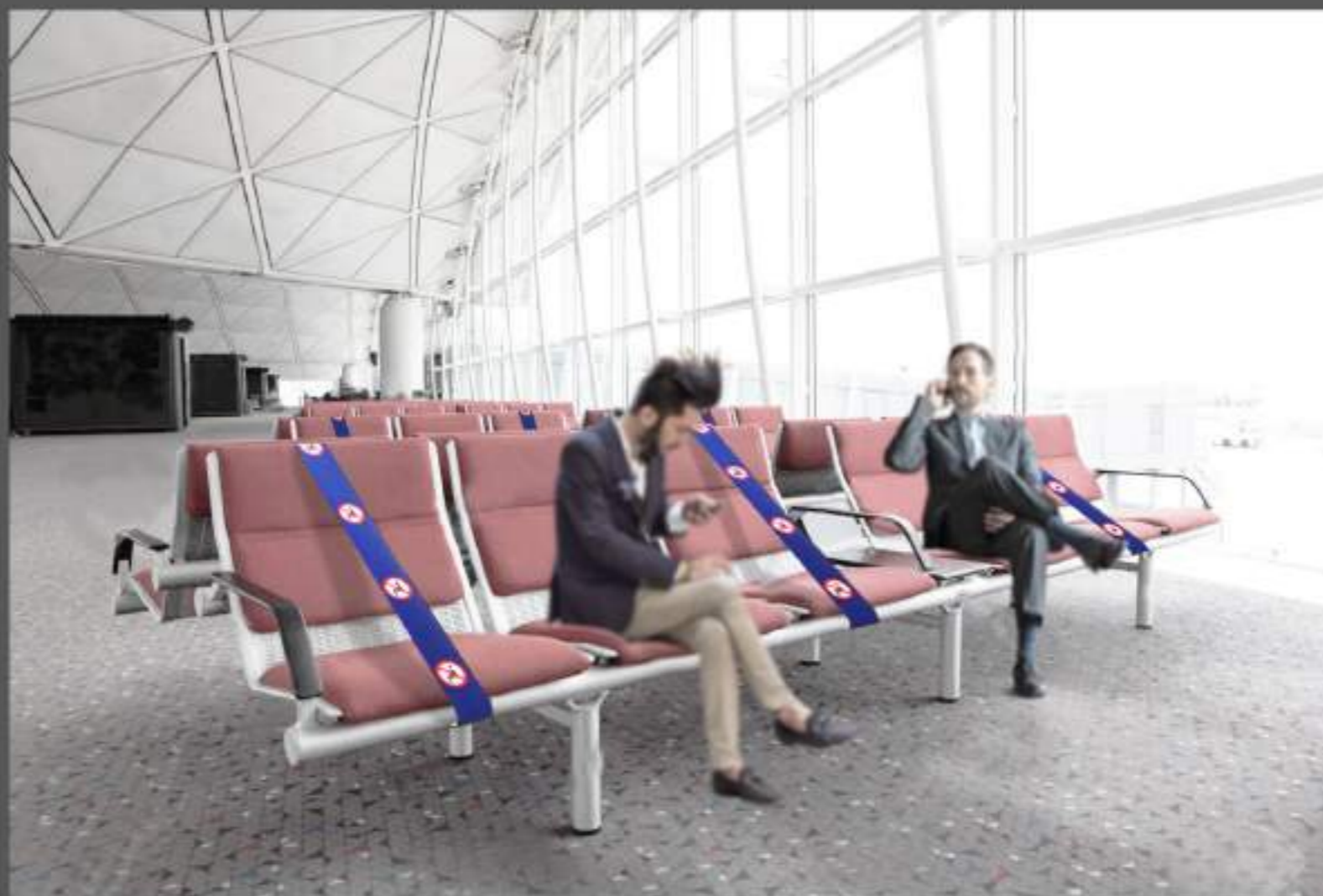

Elastic tape: 180x8 cm - dye printing and metal buckles.



7 SPRAY SIGN HOLDER WALL MOUNTED

Social distance

We have studied a product that could be fixed to the wall, its ideal placement is outside the room in order to guarantee everyone's safety. Our SPRAY SIGN HOLDER WALL is equipped with the SignLine message exchange, which can be easily customized thanks to the integrated magnetic system or in a graphic version and is equipped with a shelf for the sanitizing Spray Flex. The volume of this solution is really low.

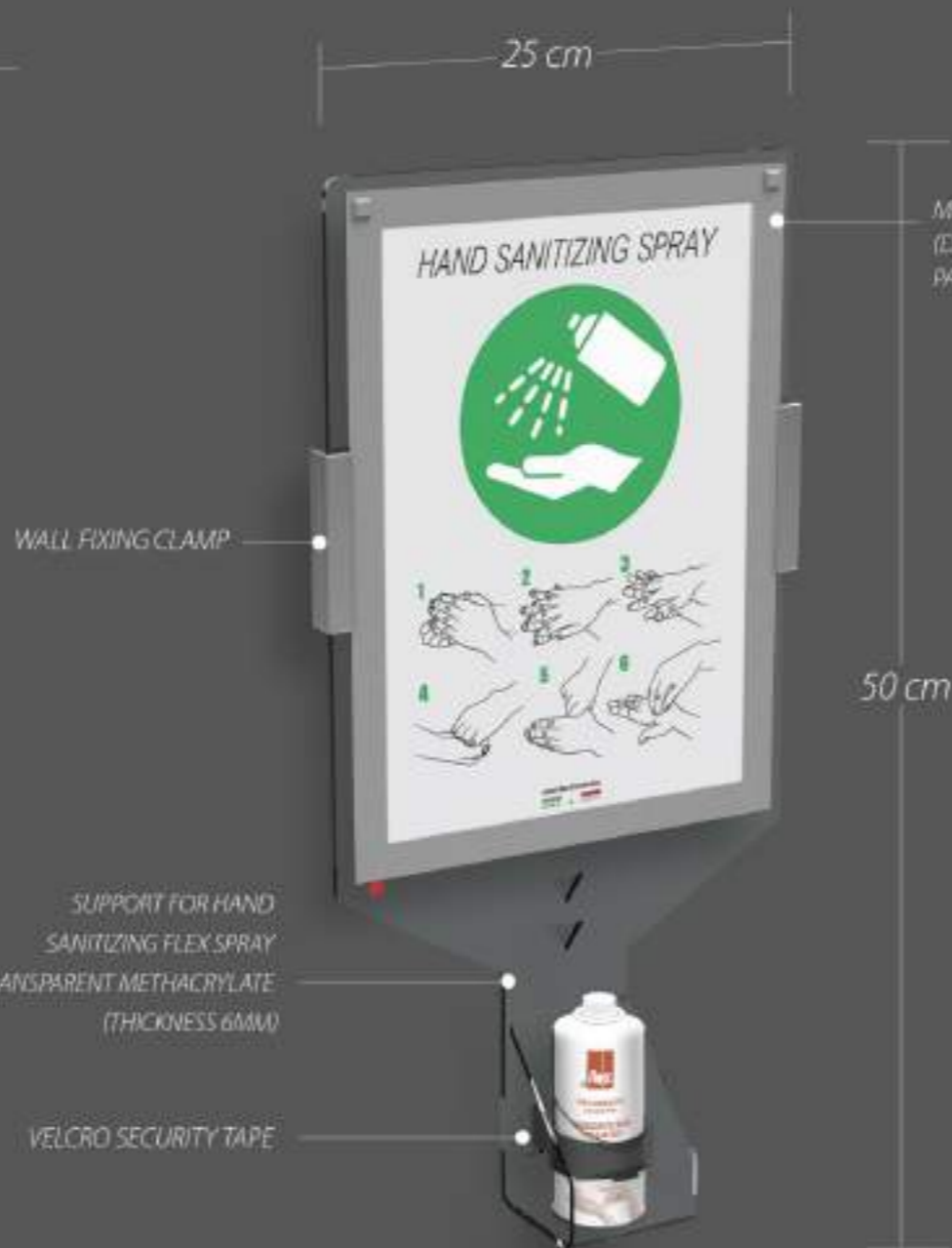

MESSAGE A4V FORMAT
(DOUBLE SIDED)
PAPER POSTER INCLUDED



EXAMPLE OF USE



QUICK POSTER REPLACEMENT: OPEN, REMOVE AND REPLACE



ACCESSORY:
pocket sanitizing spray (not included),
alcohol-based, quick action.
Directions for use: shake the bottle, spray on the
surfaces to be treated.
ALL SANITIZING PRODUCTS ARE SOLD SEPARATELY

FINISHING: TRANSPARENT METHACRYLATE AND POLISHED CHROME

7 SPRAY SIGN HOLDER WALL MOUNTED

Social distance



MESSAGE A4V FORMAT
(DOUBLE SIDED)
PAPER POSTER INCLUDED



Version with message change



CUSTOMIZED PANEL
(DOUBLE SIDED)
ADHESIVE FILM INCLUDED

Version with adhesive film

8 DISPENSER SIGN HOLDER WALL MOUNTED

Social distance

DISPENSER SIGN HOLDER WALL MOUNTED is our poster holder system available both with SignLine and graphic version which is combined with the support for sanitizing Spray Flex. With the SignLine system the message change is simple and easy to handle thanks to the magnetic system. It can be positioned in any environment, as there is the possibility to fix it to the wall. Ideal for environments where the pedestrian flows are heavy, DISPENSER SIGN HOLDER WALL allows you to sanitize your hands and guarantees a healthy context enriching it with its unique design.



ACCESSORY:
pocket sanitizing spray (not included), alcohol-based, quick action.
Directions for use: shake the bottle, spray on the surfaces to be treated.
ALL SANITIZING PRODUCTS ARE SOLD SEPARATELY

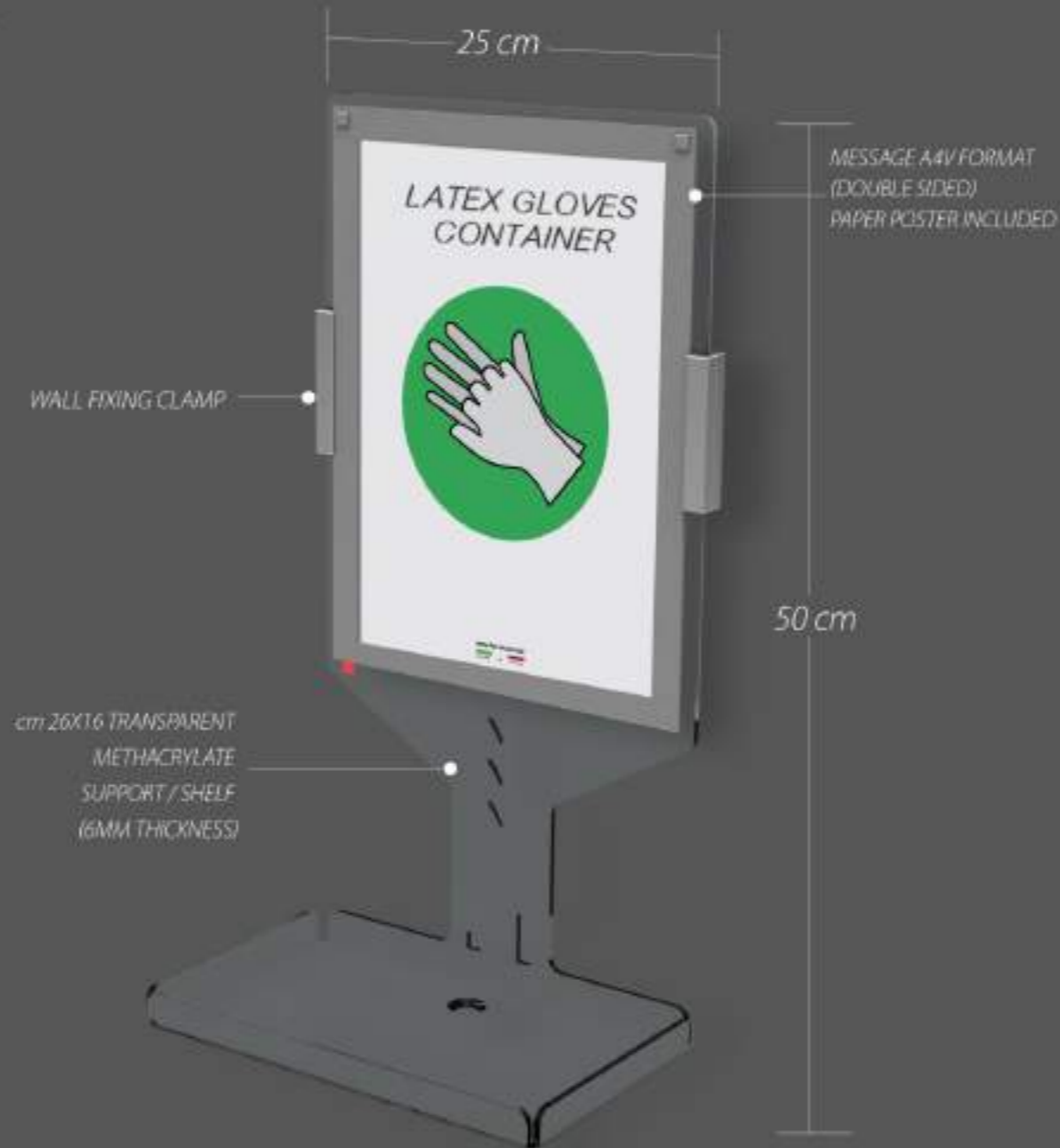

EXAMPLE OF USE



QUICK POSTER REPLACEMENT: OPEN, REMOVE AND REPLACE

8 DISPENSER SIGN HOLDER WALL MOUNTED

Social distance



19 AUTOMATIC DISPENSER WALL MOUNTED

Social distance

We have studied a product that could be fixed to the wall, its ideal placement is outside the room in order to guarantee everyone's safety. Our AUTOMATIC GEL DISPENSER (600 ml) is equipped with the SignLine message exchange, which can be easily customized thanks to the integrated magnetic system or in a graphic version and is equipped with a shelf of sippy. The volume of this solution is really low.



EXAMPLE OF USE



9 SIGN DESK

Social distance

SIGN DESK is a convenient table-top information holder whose task is to communicate the rules of behavior clearly and immediately to people inside the environment. The purity of design of the fixing block, combined with the transparency of the surfaces, make the product a solution that enhances any environment by enhancing every type of message. By lifting the magnetic frame, the SIGN LINE system allows rapid replacement of the card: open, remove, replace



EXAMPLE OF USE



SURFACE SANITIZING SPRAY

Social distance

SURFACE SANITIZING SPRAY

Pocket-sized, alcohol-based, fast-acting.

Sanitizes surfaces (desks, computers, keyboards, smartphones, monitors, handles, mouse etc. not suitable for leather or imitation leather products).

Non-flammable propellant with very low environmental impact.



NOT suitable for leather or imitation leather products



13,5 cm

QUANTITY: 100 ml

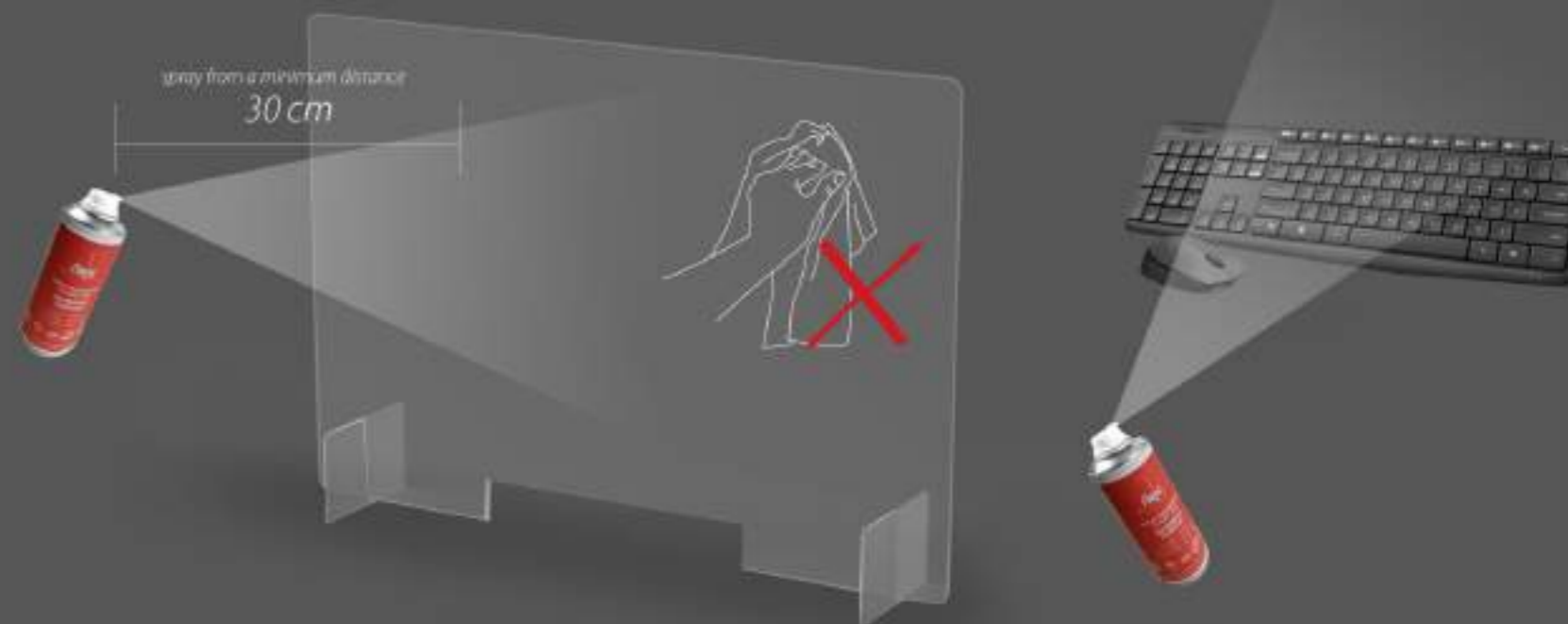

It does not require further cleaning with a cloth. Fast-acting

How to use: shake the can, spray on the surfaces to be treated and allow to evaporate.
WITHOUT RINSING / DO NOT FURTHER USE ANY TYPE OF CLOTH

PACK OF 10 PIECES



ISOPROPYL ALCOHOL SANITIZER

Social Distance

With a 90% purity, this product can be used as a cleaner, de-greaser or either solvent. The isopropyl alcohol is colorless and clear, does not contain colorants or odors and is friendly to use. It cleans and removes all types of dirt deeply, halos and fingerprints from any surface, evaporating quickly and without leaving any residues. It can be used for the cleaning of domestic environments, brushes, cell phones or smartphones, mousepads, keyboards, monitors, com-puters and laptops, electronic devices such as CD / DVDs, magnetic tapes, printed circuit boards. Also useful for cleaning optical devices such as lenses, photo lens/gear and microscopes.

PACK OF 12 PIECES



QUANTITY: 400 ml



NOT suitable for leather or imitation leather products

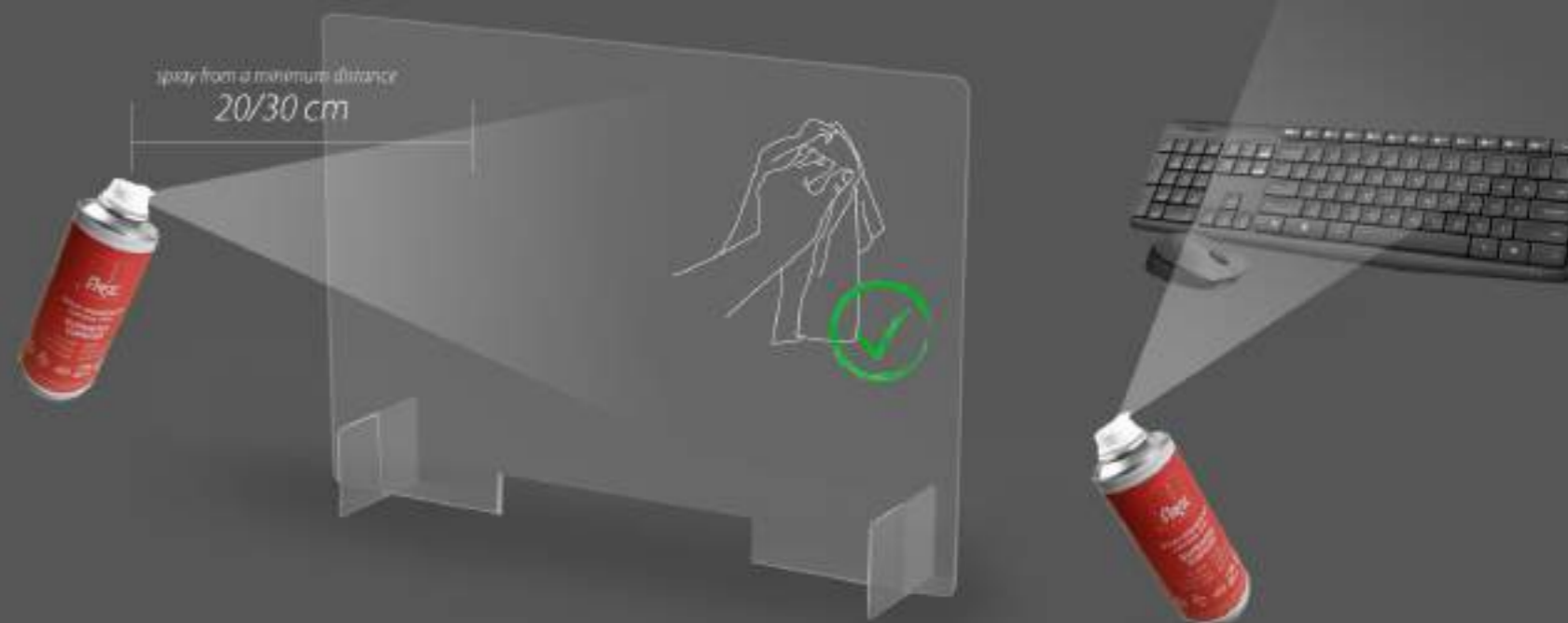

How to use:

1. Spray the product directly on the surface or spray on a cloth to then apply.
2. Wipe the surface with a clean cloth.
3. Repeat the cleaning process if necessary.
4. Wait for the complete evaporation of the solvent.

ENVIRONMENT DISINFECTANT SPRAY

Social Distance

Isopropyl alcohol based product designed for a rapid and effective disinfecting action of offices, laboratories, waiting rooms, meeting rooms and rooms with medium-large surfaces in general. Its virucidal and bactericidal action, is capable of neutralizing unpleasant odors and completely disinfecting environments. An efficient and non-invasive treatment without side effects for electrical equipment such as telephones, computers, screens, etc.



20 cm

QUANTITY: 400 ml



VIRUCIDA AND BATTERICIDA



REMOVES ODORS UNPLEASANT



PACK OF 12 PIECES



x12

How to use:

1. Remove the cap from the bottle and shake the bottle vigorously for 5 seconds.
2. Dispense the product uniformly in all the rooms to be disinfected, directing the spray upwards.
3. Leave the product to act, then ventilate the treated environment.

ONE-SHOT HYGIENIZIER SPRAY FOR CABINET AND SMALL ENVIRONMENTS

Social Distance

Product designed for rapid and effective cleaning action of the car. It neutralizes unpleasant smells from seats, plastics and floor mats inside the car. It can help eliminate the smell of smoke and immediately refreshes environment.



14 cm

QUANTITY: 150 ml

PACK OF 12 PIECES



VIRUCIDA AND BATTERICIDA



REMOVES ODORS UNPLEASANT



REFRESHES THE ENVIRONMENT



How to use:

Place the tank on one of the mats inside the car. Operate the air conditioning whenever possible onto the air recycling. Initiate air flow to high and close the doors. Let it soak for at least 20 minutes then ventilate. Available in different fragrances.

HAND SANITIZING SPRAY

Social distance

HAND SANITIZING SPRAY

Pocket-sized, alcohol-based, fast-acting.

Alcohol-free hand sanitizer.

Eliminates bacteria on the hands.

Perfect to carry in your pocket to have it always available. It can also be carried in your hand luggage as the quantity is within 100 ml.

Non-flammable propellant with very low environmental impact.

How to use: shake before use. Keeping the can upright, dispense the product for 2-3 seconds on the palms of the hands. Rub your hands until completely dry.



13,5 cm

QUANTITY: 100 ml

PACK OF 10 PIECES



x10





*Since 1990 Flex stands out for its dynamic, functional and **MADE IN ITALY** products. For further information, please do not hesitate to contact us.*

Phone +39 030 353.1005

www.flex.it - info@flex.it

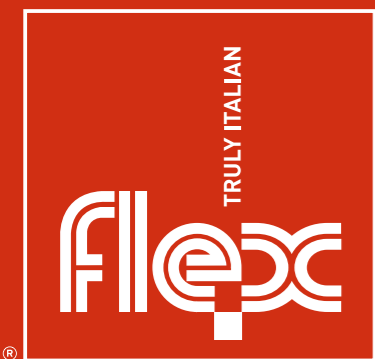

FLEX s.r.l.

Via G. Bargnani, 11

25135 Brescia (BS) - Italy

Phone +39 030 353.1005

Fax +39 030 35.310.22

www.flex.it - www.tendiflex.it - info@flex.it