



# TENDIFLEX® SPHERE

## TECHNICAL BOOK

---

DESIGN & SOLUTIONS



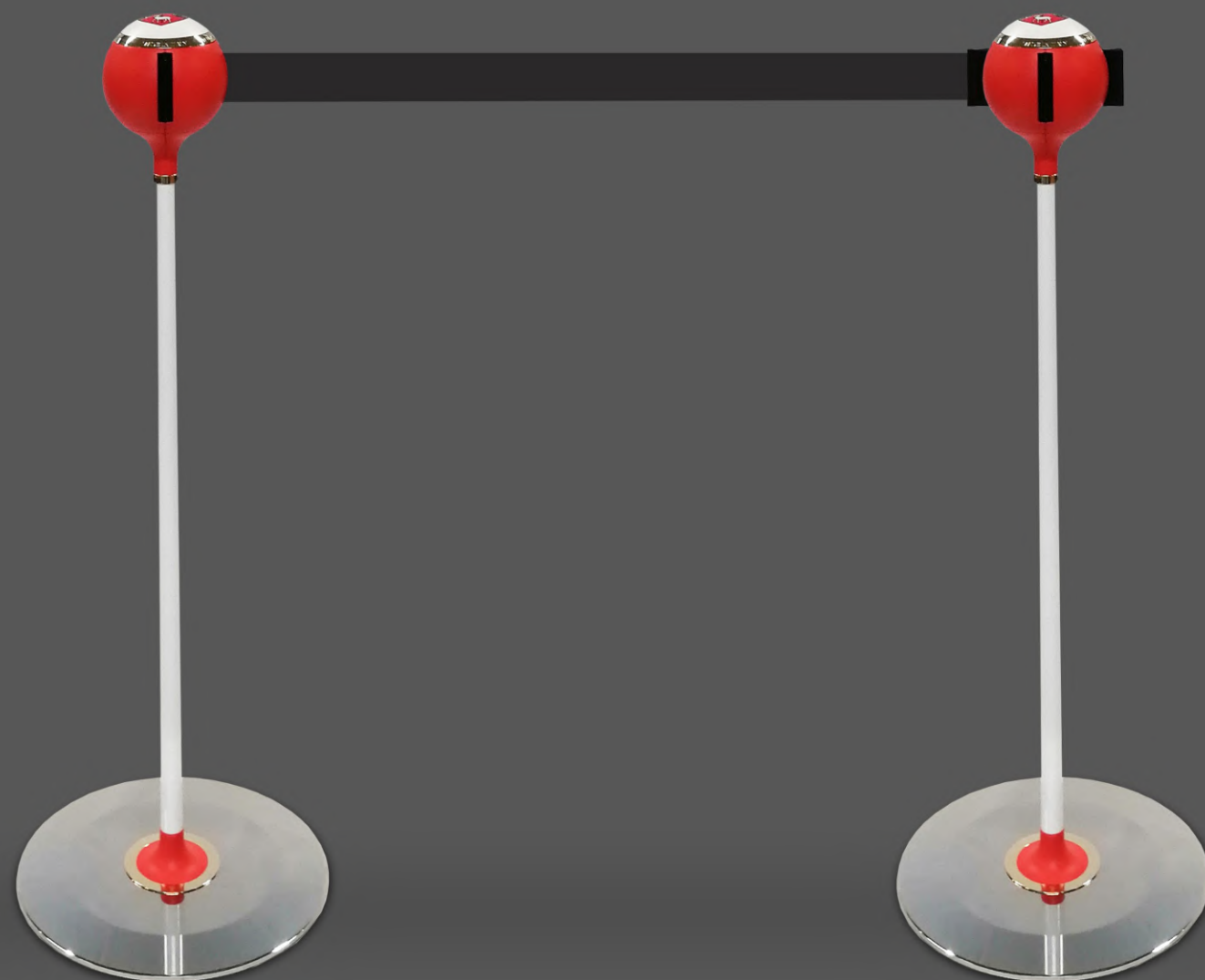

## PRODUCT BEST FEATURES/ PARTICOLARITÀ DEL PRODOTTO

- ★
**INNOVATIVE AND FUTURISTIC DESIGN/**  
*DESIGN INNOVATIVO E FUTURISTICO*
- ✎
**TOTALLY CUSTOMIZABLE PRODUCT /**  
*PERSONALIZZAZIONE TOTALE DEL PRODOTTO*
- 🔄
**SIMPLE AND QUICK CHANGE OF THE UPPER CAP/**  
*SEMPLICE E RAPIDO CAMBIO DELLA CALOTTA SUPERIORE*
- 🏠
**FLAT BASE TO FACILITATE THE MOVEMENT OF  
TROLLEYS AND SUITCASES/**  
*BASE PIATTA PER FACILITARE LA MOVIMENTAZIONE  
DI CARRELLI E VALIGE*
- ⊥
**STANDARD AND MAGNETIC BASES  
ARE AVAILABLE/**  
*DISPONIBILE CON BASE STANDARD e CON  
BASE MAGNETICA*
- 🔗
**ERGONOMIC AND MAGNETIC TAPE-END AVAILABLE/**  
*DISPONIBILE CON AGGANCIO MAGNETICO E ERGONOMICO*
- 🌀
**ALSO AVAILABLE IN THE VERSION WITH ROPE/**  
*DISPONIBILE ANCHE NELLA VERSIONE CON CORDONE*



## TOTAL CUSTOMIZATION OF THE PRODUCT/ PERSONALIZZAZIONE TOTALE DEL PRODOTTO

Our TENDIFLEX® SPHERE posts can be customized in many ways: the upper cap can be printed with the client logo and the rings can be customized with the corporate or environment colors, making each SPHERE a one-of-a-kind item.

*Le nostre colonnine TENDIFLEX® SPHERE possono essere personalizzate in svariati modi: della calotta superiore con il logo del cliente agli anelli della sfera con i colori aziendali o dell'ambiente circostante, rendendo ogni SPHERE un oggetto unico nel suo genere.*

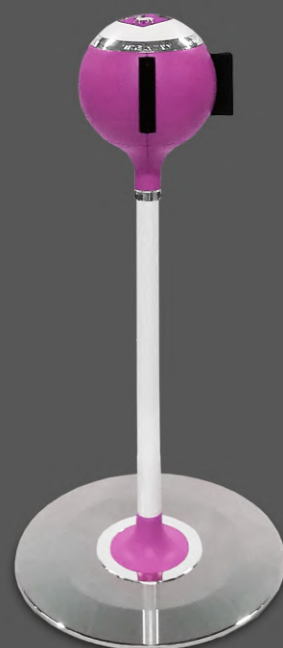

Height / altezza: 560 mm

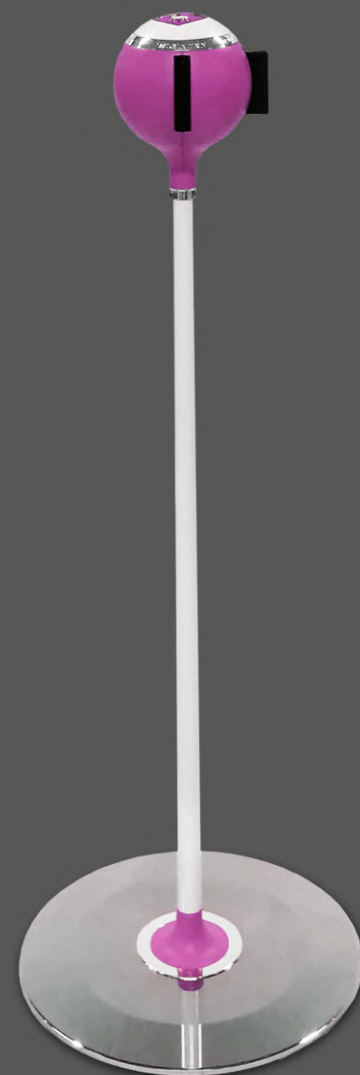

Height / altezza: 976 mm

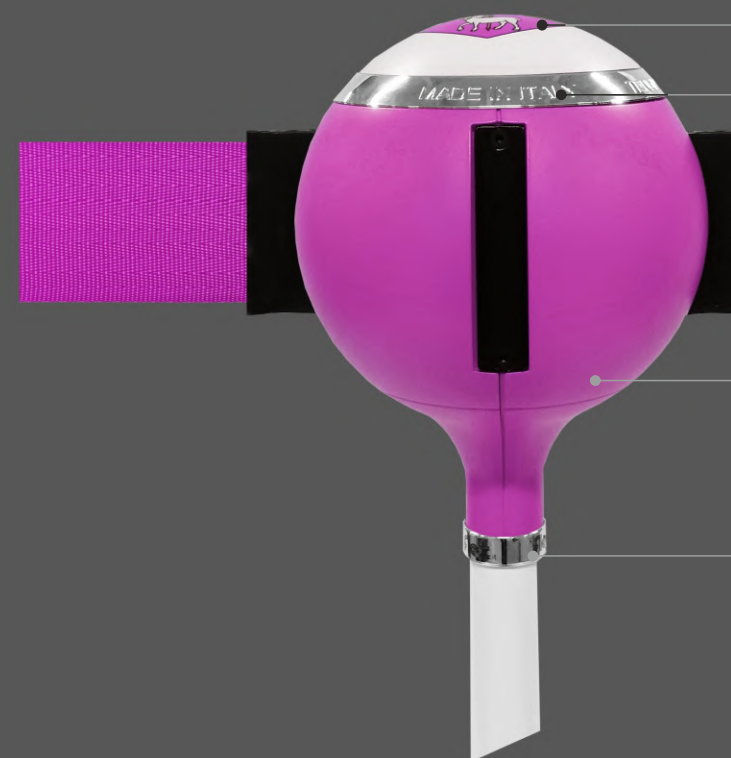

Customizable upper cap/  
Calotta superiore personalizzabile

Colored upper ring/  
Anello superiore colorato

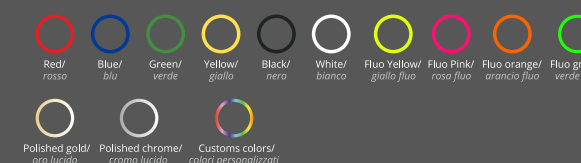

Sphere head in ABS/  
Testina composta da due scocche in ABS



Colored collar ring/  
Anello collarino colorato

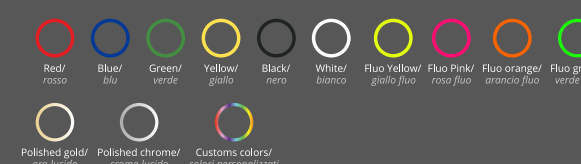

Ø 25 mm steel post/  
Montante in acciaio Ø 25 mm

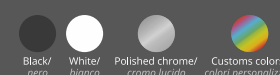

Colored base cover in ABS  
Cover di base colorato in ABS

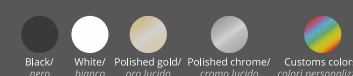

Colored lower ring/  
Anello inferiore colorato

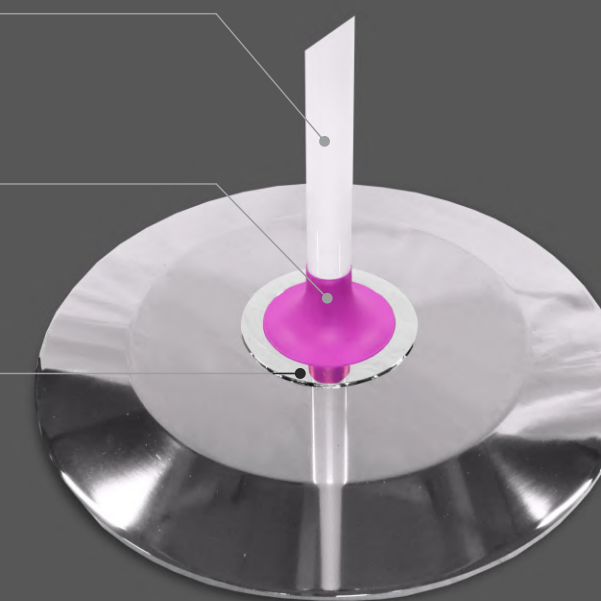



## SIMPLE AND QUICK CHANGE OF THE UPPER CAP/ SEMPLICE E RAPIDO CAMBIO DELLA CALOTTA SUPERIORE

The quick and simple change of the upper cap of our TENDIFLEX® SPHERE gives a completely new look to the product in just a few seconds, making it perfect for any environment.

*Il cambio rapido e semplice della calotta della nostra TENDIFLEX® SPHERE consente di dare una nuova veste al prodotto in pochi secondi, rendendolo perfetto per ogni ambiente.*







## ERGONOMIC AND MAGNETIC TAPE-END VERSION AVAILABLE/ DISPONIBILE CON AGGANCIAMENTO ERGONOMICO E MAGNETICO

Our TENDIFLEX® SPHERE is available with 2 different types of tape-end:

**Ergonomic:** suggested in crowded environments such as airports and train stations.

**Magnetic:** allows a simple and fast “release” of the belt. Ideal in situations where safety is a priority.

La nostra TENDIFLEX® SPHERE è disponibile con 2 differenti tipologie di aggancio del nastro:

**Ergonomico:** consigliata in ambienti affollati come aeroporti e stazioni ferroviarie.

**Magnetico:** consente un “rilascio” semplice e veloce del nastro. Ideale in situazioni in cui la sicurezza è una priorità.

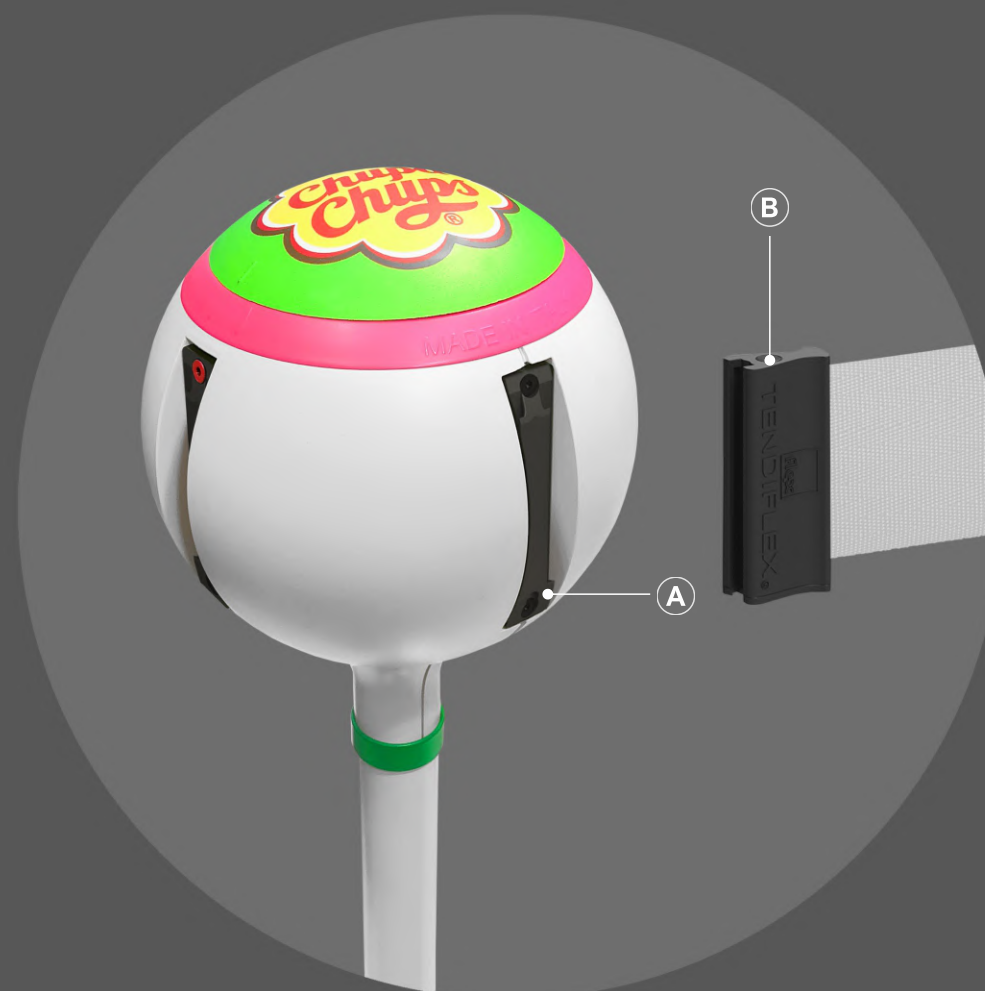

ERGONOMIC TAPE END/  
AGGANCIAMENTO ERGONOMICO



MAGNETIC TAPE END/  
AGGANCIAMENTO MAGNETICO

- A** Standard spline  
*Spline standard*
- B** Standard ergonomic tape-end/  
*Aggancio ergonomico*
- C** Spline + steel plate receiver/  
*Spline + ricevitore in acciaio*
- D** Tape-end with magnets/  
*Aggancio con magneti*





## TOTAL BELT CUSTOMIZATION/ PERSONALIZZAZIONE TOTALE DEL NASTRO

The infinite resources of this product also allow to fully customize the expandable belt, thus creating a truly unique product. Company logos, event graphics, images, corporate colours, text, and directional wayfinding are just some possible uses.

*Le infinite risorse di questo prodotto permettono di personalizzare il nastro estensibile con loghi e colori aziendali, fungendo così da importante strumento di marketing grazie alla sua totale customizzazione.*

### Fabric

Crease-proof polyester.

Glow Wire Test at a temperature of 650° accordance with IEC 60695-2-10 - IEC 60695-2-11

### Tessuto

Poliestere antistazzonamento.

Glow Wire Test ad una temperatura di 650° secondo le norme IEC 60695-2-10 - IEC 60695-2-11

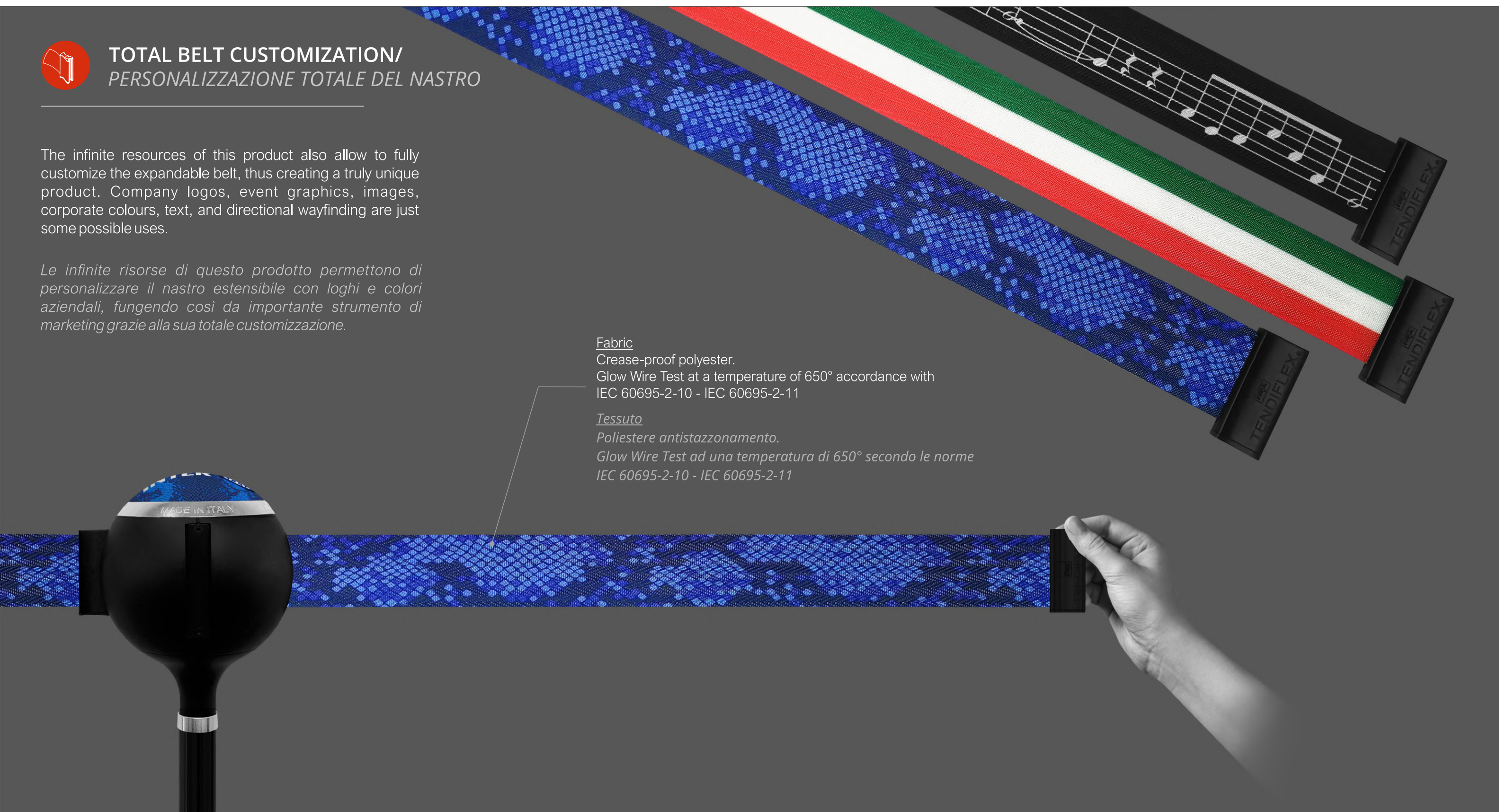





## WEBBING COLORS AVAILABLE/ COLORI NASTRI DISPONIBILI

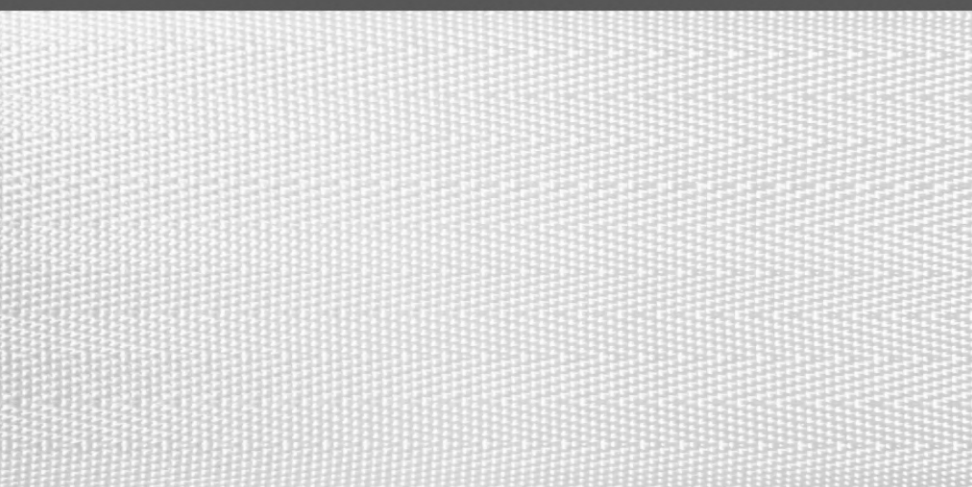

### VERSION 230:

Height: 48 mm  
Length: 2300 mm  
Thickness: 0,80 +/-0,05 mm

### VERSIONE 230:

Altezza: 48 mm  
Lunghezza: 2300 mm  
Spessore: 0,80 +/-0,05 mm

### VERSION 330:

Height: 48 mm  
Length: 3300 mm  
Thickness: 0,60 +/-0,05 mm

### VERSIONE 330:

Altezza: 48 mm  
Lunghezza: 3300 mm  
Spessore: 0,60 +/-0,05 mm

## STANDARD COLORS



Red / rosso



Green / verde



Blue / blu

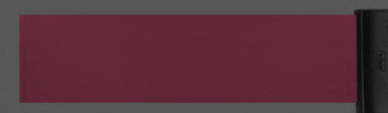

Burgundy / bordeaux



Neptune green / verde nettuno



Yellow / giallo



Brown / marrone



Black / nero



Grey / grigio

## FLUO COLORS

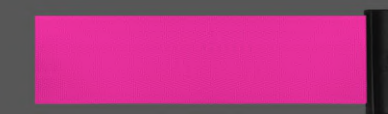

Fluo pink / rosa fluo

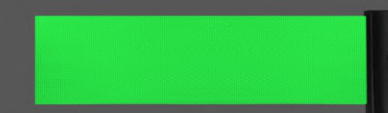

Fluo green / verde fluo



Fluo yellow / giallo fluo



Fluo orange / arancio fluo



Custom color /  
Colore su richiesta



## TENDIFLEX® SPHERE WITH CORD/ TENDIFLEX® SPHERE CON CORDONE

Our TENDIFLEX® SPHERE posts can be configured with an 18 mm diameter cord, which makes the product elegant and refined and suitable for more sophisticated environments. The bead is fixed to the sphere thanks to the magnetic plate which hooks directly to the spline of the post.

*Le nostre colonnine TENDIFLEX® SPHERE possono essere configurate anche con un cordone diametro 18 mm, che rende il prodotto elegante e raffinato e adatto ad ambienti più ricercati. Il cordone viene fissato alla sfera grazie alla piastrina magnetica che si aggancia direttamente alla spline della colonnina.*



Magnetic terminal for rope fixing/  
Terminale magnetico per fissaggio cordone



Block for cordon passage/  
Blocchetto per passaggio cordone

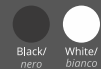

Colored rope diameter 18 mm/  
Cordone colorato diametro 18 mm



Magnetic fixing of the rope/  
Fissaggio magnetico del cordone



## FLAT BASE TO FACILITATE THE MOVEMENT OF TROLLEYS AND SUITCASES/ BASE PIATTA PER FACILITARE LA MOVIMENTAZIONE DI CARRELLI E VALIGE

The standard and magnetic bases of our TENDIFLEX® SPHERE have a very low thickness and a 7 ° diagonal chamfer, fundamental characteristics for a smooth pedestrian flow, especially in environments such as airports and stations.

*Le basi standard e magnetiche della nostra TENDIFLEX® SPHERE hanno uno spessore molto ridotto e uno smusso diagonale di 7°, caratteristiche fondamentali per il corretto flusso pedonale, soprattutto in ambienti come aeroporti e stazioni.*

Example of a common high thickness base/  
*Esempio di comune base ad alto spessore*

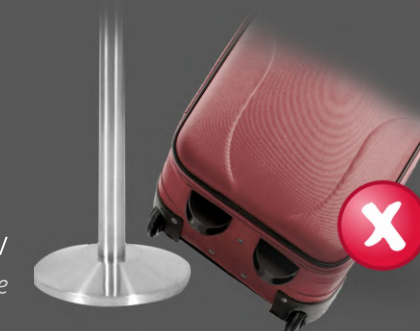

Flat base - solid steel 13,5 mm thick/  
*Base piatta - acciaio pieno spessore 13,5 mm*

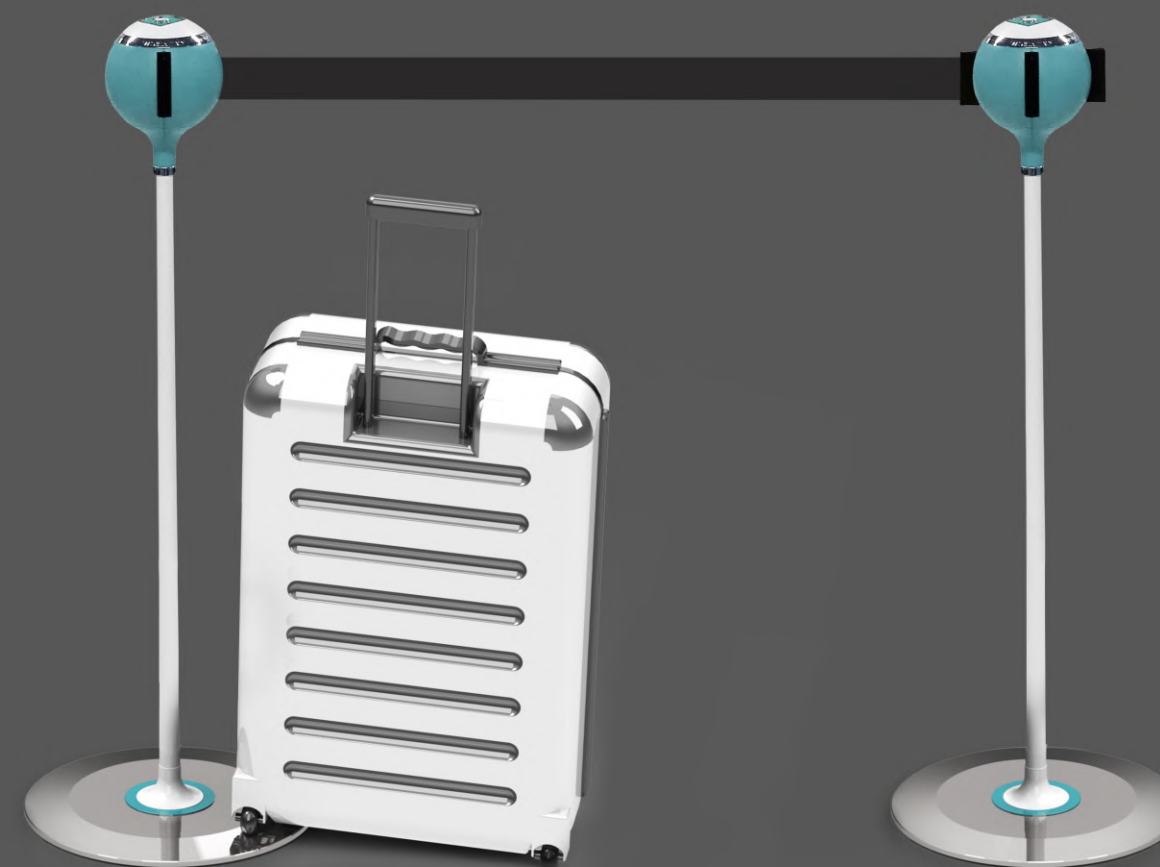





## FLAT BASE - BASE VERSIONS/ BASE PIATTA - VERSIONI BASE

The 180mm and 280mm diameter magnetic base allow to increase the space dedicated to pedestrian flows thanks to its reduced diameter compared to the 350mm standard one.

*Le magnetiche con diametro 180mm e 280mm consentono di aumentare gli spazi dedicati al flusso pedonale grazie ad un diametro ridotto rispetto alla base standard da 350mm.*

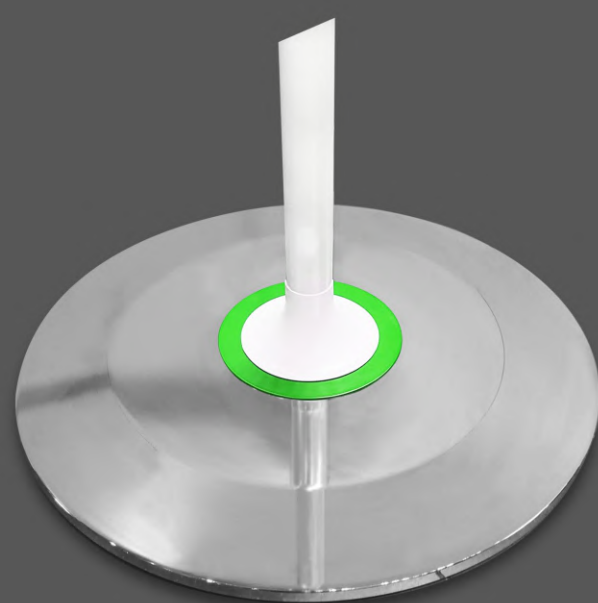

**Ø 350 mm**

STANDARD BASE Ø 350 mm/  
BASE STANDARD Ø 350 mm

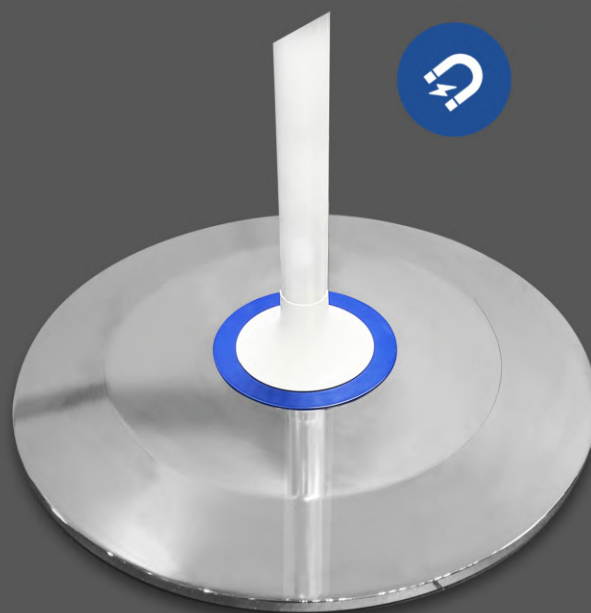

**Ø 350 mm**

MAGNETIC BASE Ø 350 mm/  
BASE MAGNETICA Ø 350 mm

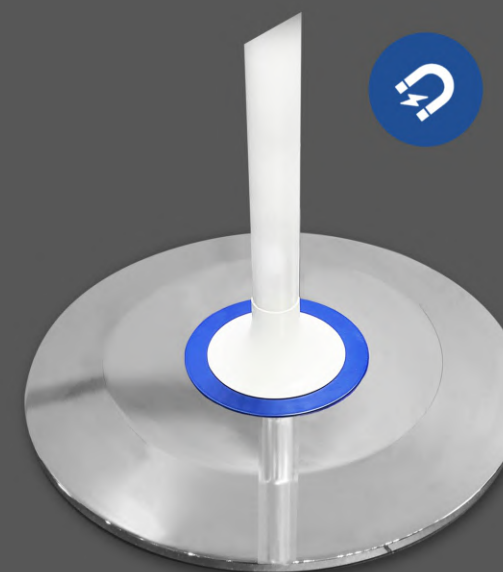

**Ø 280 mm**

MAGNETIC BASE Ø 280 mm/  
BASE MAGNETICA Ø 280 mm



**Ø 180 mm**

MAGNETIC BASE Ø 180 mm/  
BASE MAGNETICA Ø 180 mm



STANDARD BASE ARE AVAILABLE/  
DISPONIBILE CON BASE STANDARD

Ø 350 mm

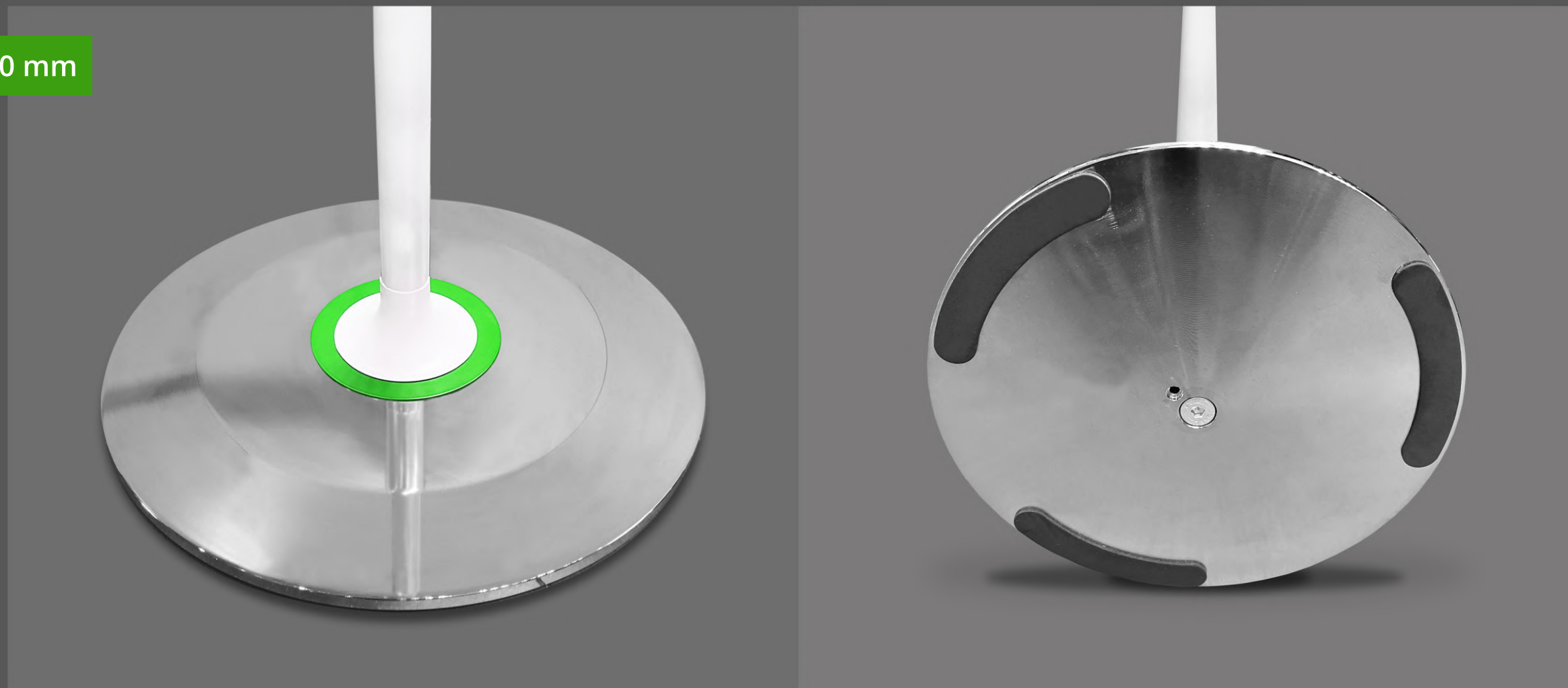

The standard base of TENDIFLEX® SPHERE, with a diameter of 350mm, makes the product stable thanks also to its weight of 8.7 kg. The steel base is very thin with a slight groove that makes it optimal in environments with high pedestrian flow.

*La base standard della TENDIFLEX® SPHERE, dal diametro di 350mm, rende il prodotto stabile grazie anche al suo peso di 8,7 kg. La base, in acciaio, risulta molto sottile con una leggera scanalatura che la rende ottimale in ambienti ad alto flusso pedonale.*



MAGNETIC BASE ARE AVAILABLE/  
DISPONIBILE CON BASE MAGNETICA

Ø 350 mm

Ø 280 mm

Ø 180 mm

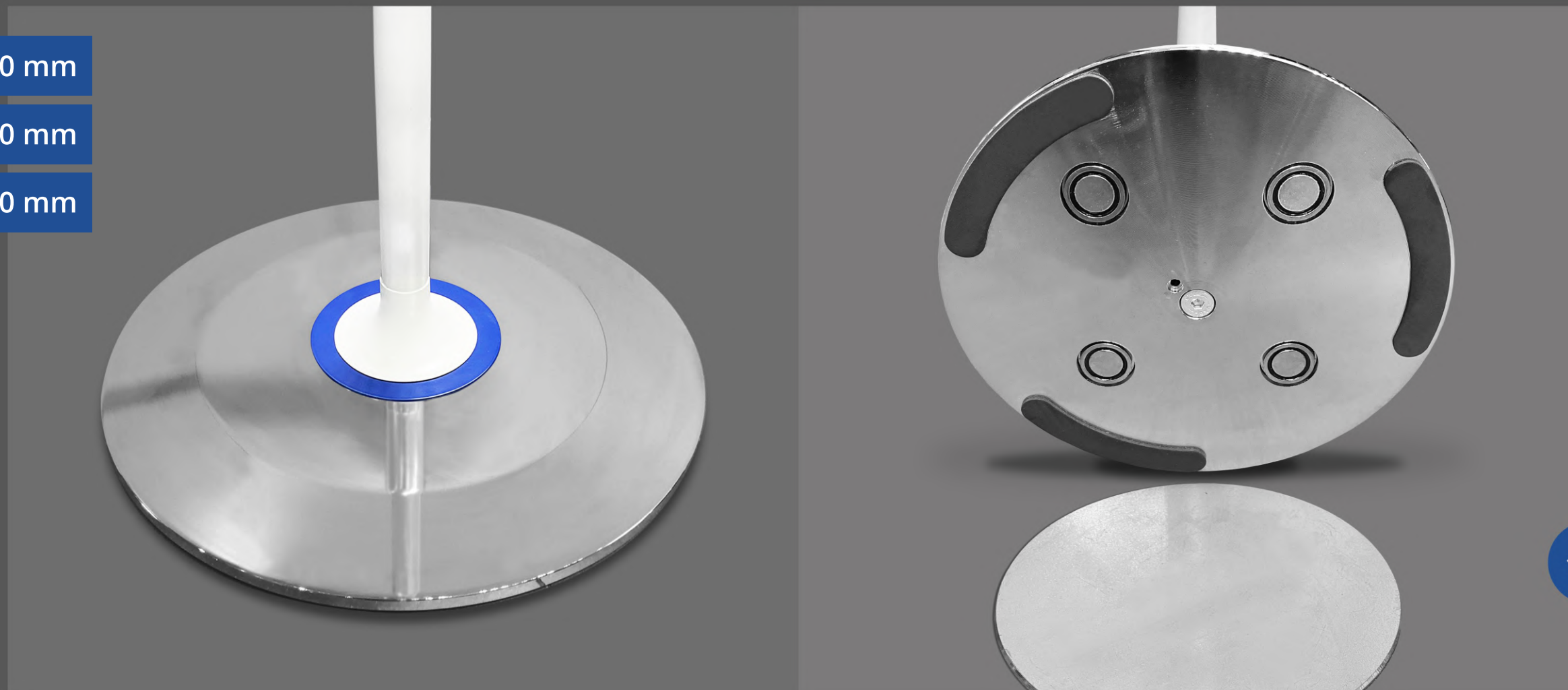

TENDIFLEX® SPHERE can be installed with magnetic fixing to the ground thanks to the galvanized disc positioned on the floor and the 4 magnets under the base of the post. The galvanized disks, supplied together with the posts, are fixed to the ground with 3M double-sided tape. They don't require any drilling operations.

*TENDIFLEX® SPHERE può essere installata con fissaggio magnetico al suolo, grazie al disco zincato posizionato sul pavimento e ai 4 magneti sotto la base della colonnina. I dischi zincati, forniti insieme alla colonnina, vengono fissati al suolo con biadesivo 3M e non necessitano di operazioni di foratura.*



## TENDIFLEX® SPHERE SIGN HOLDER/ PORTA CARTELLO PER TENDIFLEX® SPHERE

The TENDIFLEX® SPHERE post can come with additional accessories, such as the sign holder with shockproof transparent methacrylate panel, which allows a quick message replacement by simply changing the communication inside.

*La colonnina TENDIFLEX® SPHERE può essere dotata di accessori aggiuntivi, come il porta cartello con pannello in metacrilato trasparente antiurto, che consente un rapido cambio del messaggio semplicemente cambiando la comunicazione all'interno.*



Double-sided methacrylate  
Sign holder/  
*Pannello porta cartello bifacciale  
In metacrilato*

Brass frame.  
Finishing: painted black or polished chrome  
*Cornice in ottone.  
Finitura: verniciato nero o cromo lucido*



High-strength polyamide (pa) cone/  
*Cono in poliammide (pa) ad alta resistenza*

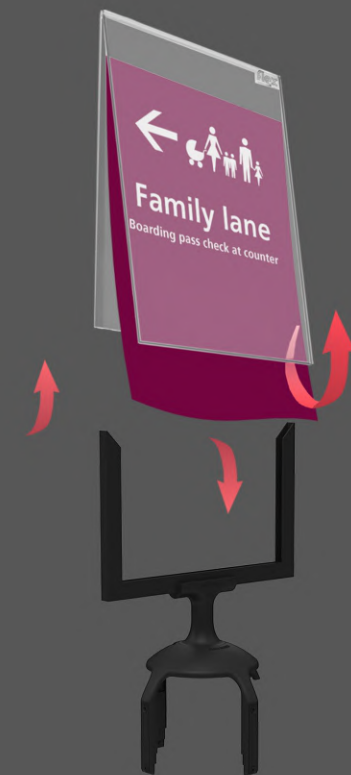

Quick and easy change of message/  
*Semplice e rapido cambio del messaggio*



ACC

## TENDIFLEX® SPHERE SHELF/ MENSOLA PER TENDIFLEX® SPHERE

The TENDIFLEX® SPHERE also features another additional accessory: the white methacrylate shelf, available in both the square and round versions, perfect for displaying your products and entertaining your customers during queues.

*La TENDIFLEX® SPHERE dispone anche di un altro accessorio aggiuntivo: la mensola in metacrilato bianco, disponibile sia nella versione quadrata che tonda, perfetta per esporre i tuoi prodotti e intrattenere i tuoi clienti durante le code.*

Square shelf in white methacrylate  
Size: 354x354 mm/

*Mensola quadrata in metacrilato bianco  
Dimensioni: 354x354 mm*

Round shelf in white methacrylate  
Size: Ø 350 mm/

*Mensola tonda in metacrilato bianco  
Dimensioni: Ø 350 mm*

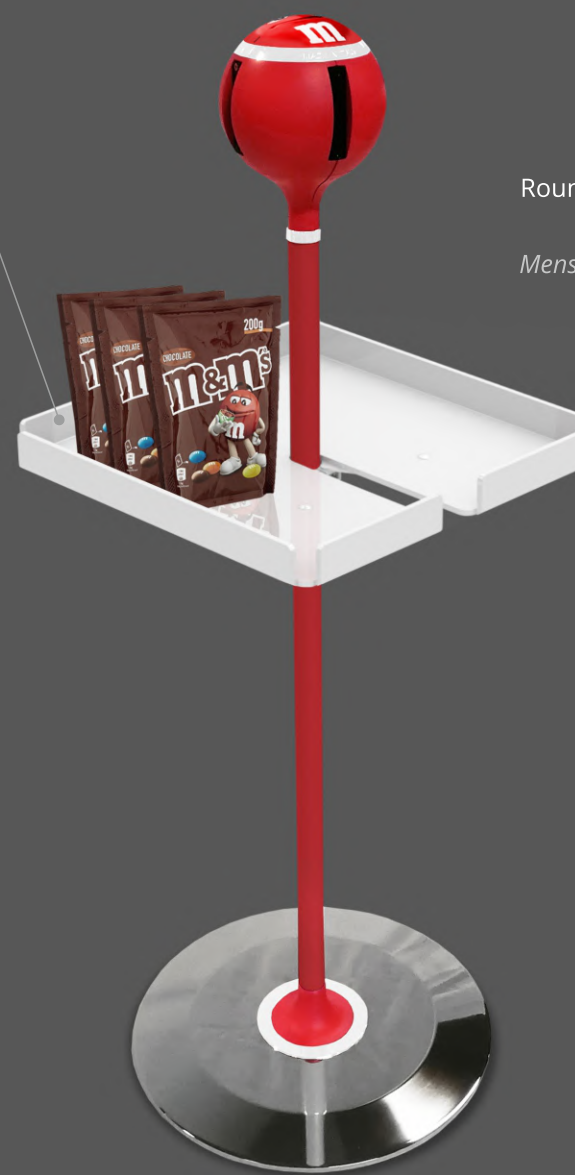





## TENDIFLEX® SPHERE MINI VERSION/ TENDIFLEX® SPHERE VERSIONE MINI

TENDIFLEX® SPHERE MINI, only 59 cm high, discreet but at the same time captivating and communicative. Ideal for museums, art galleries, car displays, food banks, etc.

*TENDIFLEX® SPHERE MINI, alte solo 59 cm, discrete ma allo stesso tempo accattivanti e comunicative. Ideali per musei, gallerie d'arte, esposizioni di automobili, banchi alimentari, ecc.*

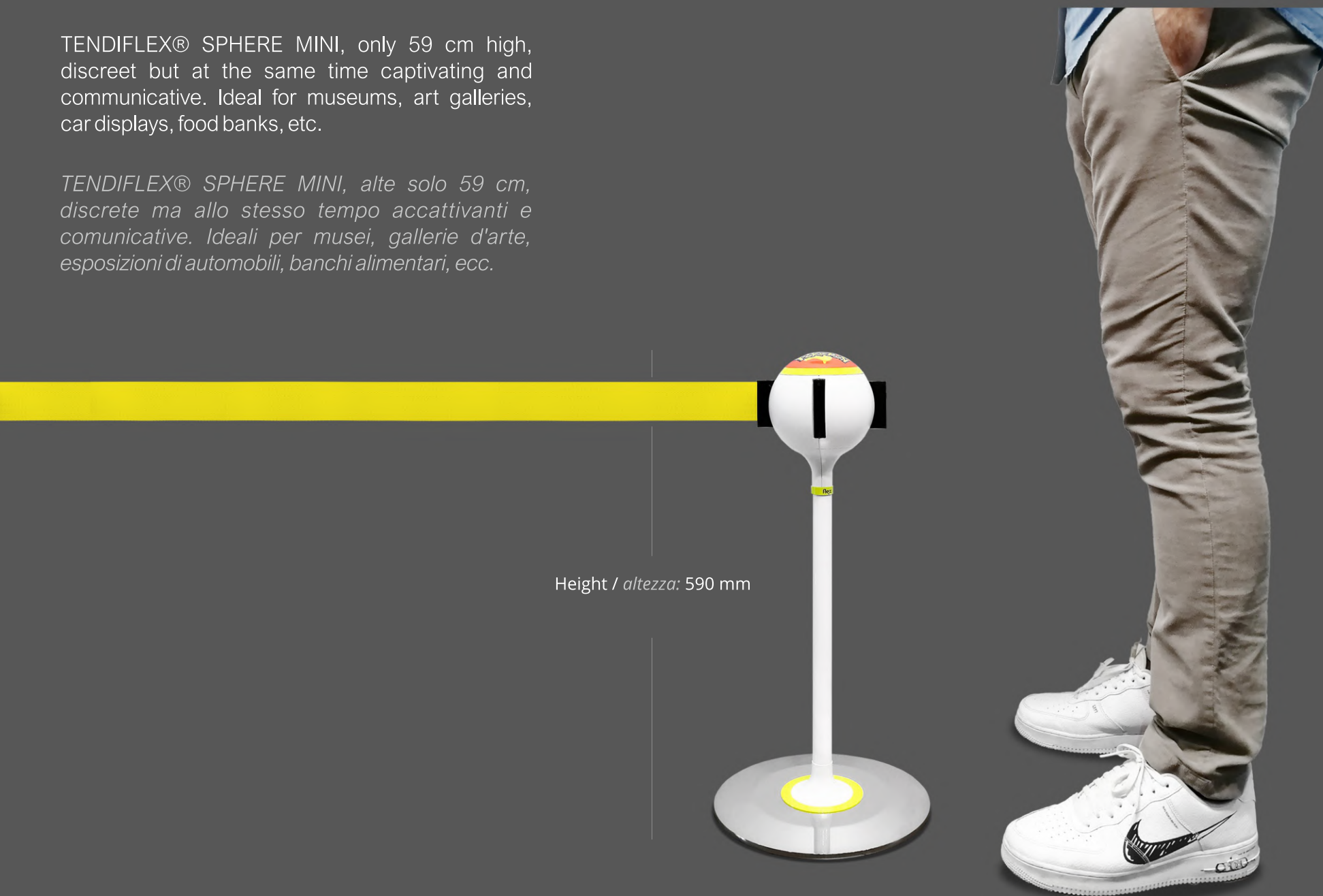

Height / altezza: 590 mm

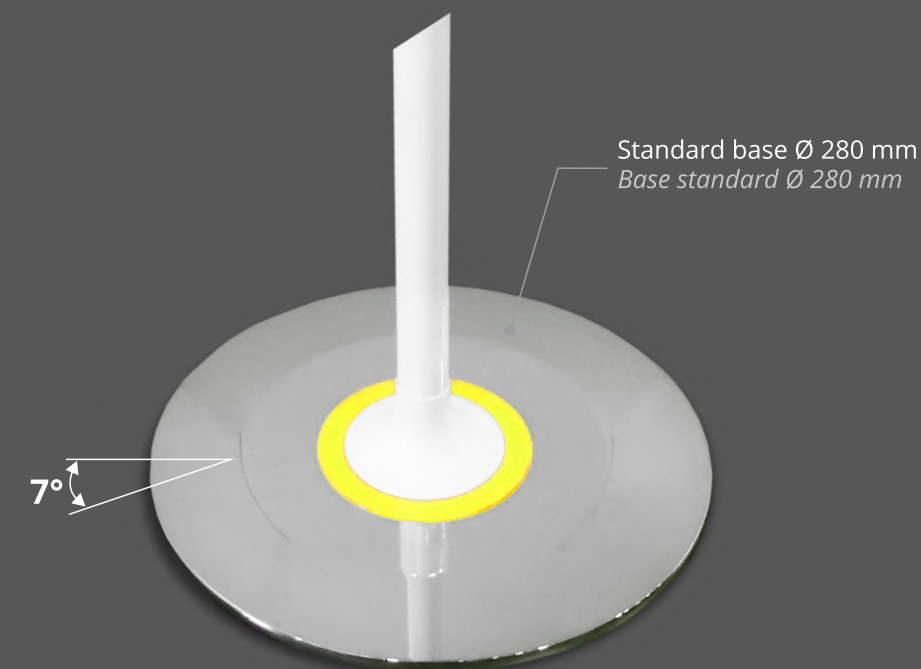

Standard base Ø 280 mm  
Base standard Ø 280 mm

Flat base - solid stell 13,5 mm thick/  
Base piatta - acciaio pieno spessore 13,5 mm



## EXAMPLES OF CUSTOMIZATION - LUXURY, FASHION and RETAIL / ESEMPI DI PERSONALIZZAZIONE - LUSO, MODA e DETTAGLIO

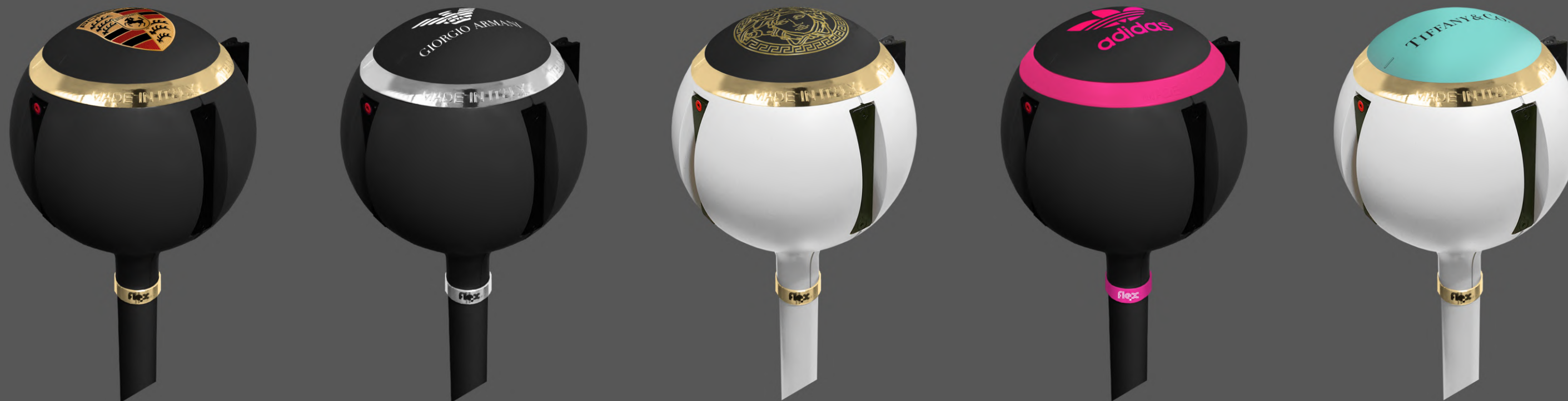

All logos and brands represented in this catalogue are used by way of example only and shall not be considered exploited for commercial and advertising purposes. We apologize for any misinterpretation and inconvenience that may occur.

*I loghi e i marchi rappresentati in questo catalogo vengono utilizzati solo a titolo esemplificativo e non devono intendersi sfruttati per fini commerciali e pubblicitari. Ci scusiamo per qualsiasi errore di interpretazione ed inconveniente che possa verificarsi.*



## EXAMPLES OF CUSTOMIZATION - PUBLIC BODIES, MUSEUMS and ART/ ESEMPI DI PERSONALIZZAZIONE - ENTI PUBBLICI, MUSEI e ARTE



All logos and brands represented in this catalogue are used by way of example only and shall not be considered exploited for commercial and advertising purposes. We apologize for any misinterpretation and inconvenience that may occur.

*I loghi e i marchi rappresentati in questo catalogo vengono utilizzati solo a titolo esemplificativo e non devono intendersi sfruttati per fini commerciali e pubblicitari. Ci scusiamo per qualsiasi errore di interpretazione ed inconveniente che possa verificarsi.*





## EXAMPLES OF CUSTOMIZATION - HOTEL, RESTAURANT and FINANCIAL GROUP / ESEMPI DI PERSONALIZZAZIONE - HOTEL, RISTORANTI e GRUPPI FINANZIARI



All logos and brands represented in this catalogue are used by way of example only and shall not be considered exploited for commercial and advertising purposes. We apologize for any misinterpretation and inconvenience that may occur.

*I loghi e i marchi rappresentati in questo catalogo vengono utilizzati solo a titolo esemplificativo e non devono intendersi sfruttati per fini commerciali e pubblicitari. Ci scusiamo per qualsiasi errore di interpretazione ed inconveniente che possa verificarsi.*



## EXAMPLES OF CUSTOMIZATION - CINEMA, THEATERS and SPORT/ ESEMPI DI PERSONALIZZAZIONE - CINEMA, TEATRI e SPORT

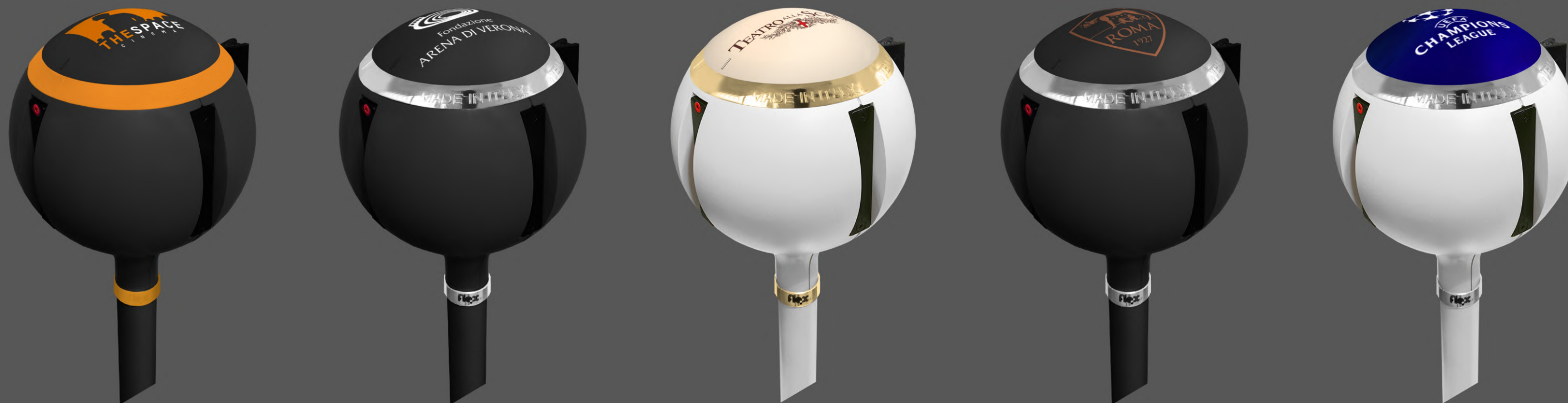

All logos and brands represented in this catalogue are used by way of example only and shall not be considered exploited for commercial and advertising purposes. We apologize for any misinterpretation and inconvenience that may occur.

*I loghi e i marchi rappresentati in questo catalogo vengono utilizzati solo a titolo esemplificativo e non devono intendersi sfruttati per fini commerciali e pubblicitari. Ci scusiamo per qualsiasi errore di interpretazione ed inconveniente che possa verificarsi.*





## EXAMPLES OF CUSTOMIZATION - SPACE FORCE and TRANSPORT SERVICES/ ESEMPI DI PERSONALIZZAZIONE - FORZA SPAZIALE e TRASPORTI

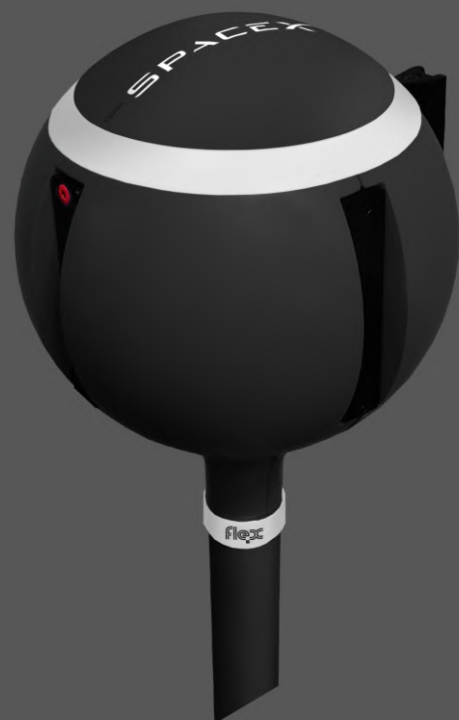

All logos and brands represented in this catalogue are used by way of example only and shall not be considered exploited for commercial and advertising purposes. We apologize for any misinterpretation and inconvenience that may occur.

*I loghi e i marchi rappresentati in questo catalogo vengono utilizzati solo a titolo esemplificativo e non devono intendersi sfruttati per fini commerciali e pubblicitari. Ci scusiamo per qualsiasi errore di interpretazione ed inconveniente che possa verificarsi.*



## EXAMPLES OF CUSTOMIZATION - THEME PARKS, SHOPS and EVENTS WEDDING/ ESEMPI DI PERSONALIZZAZIONE - PARCHI A TEMA, SHOP e CERIMONIE

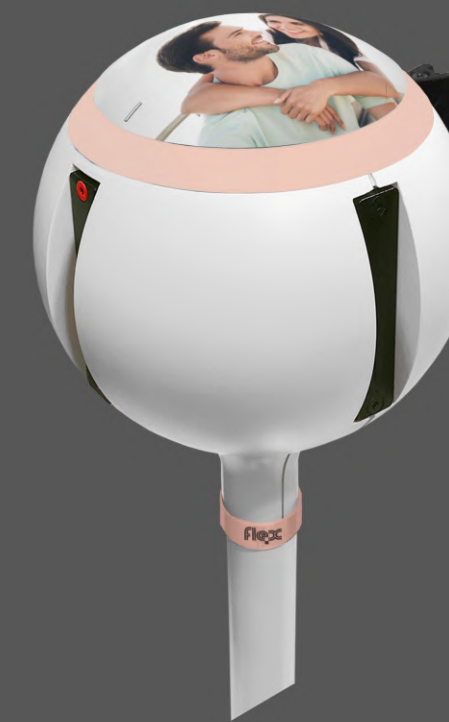
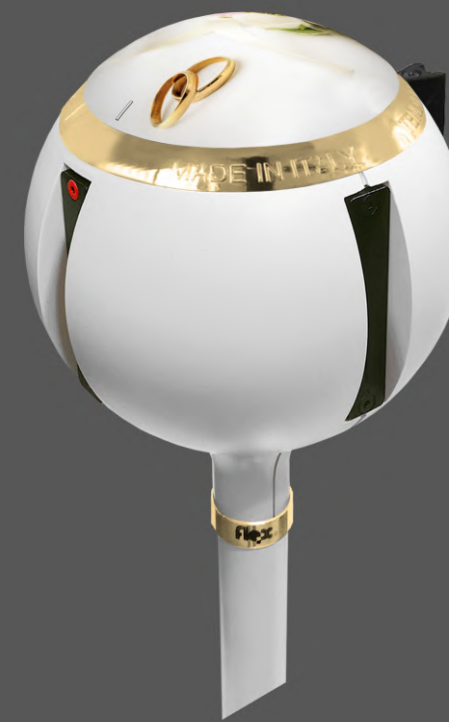

All logos and brands represented in this catalogue are used by way of example only and shall not be considered exploited for commercial and advertising purposes. We apologize for any misinterpretation and inconvenience that may occur.

*I loghi e i marchi rappresentati in questo catalogo vengono utilizzati solo a titolo esemplificativo e non devono intendersi sfruttati per fini commerciali e pubblicitari. Ci scusiamo per qualsiasi errore di interpretazione ed inconveniente che possa verificarsi.*



## TENDIFLEX® SPHERE - FINISHES and COLORS/ TENDIFLEX® SPHERE - COLORI E FINITURE

COLORS and FINISHES AVAILABLE / COLORI e FINITURE DISPONIBILI

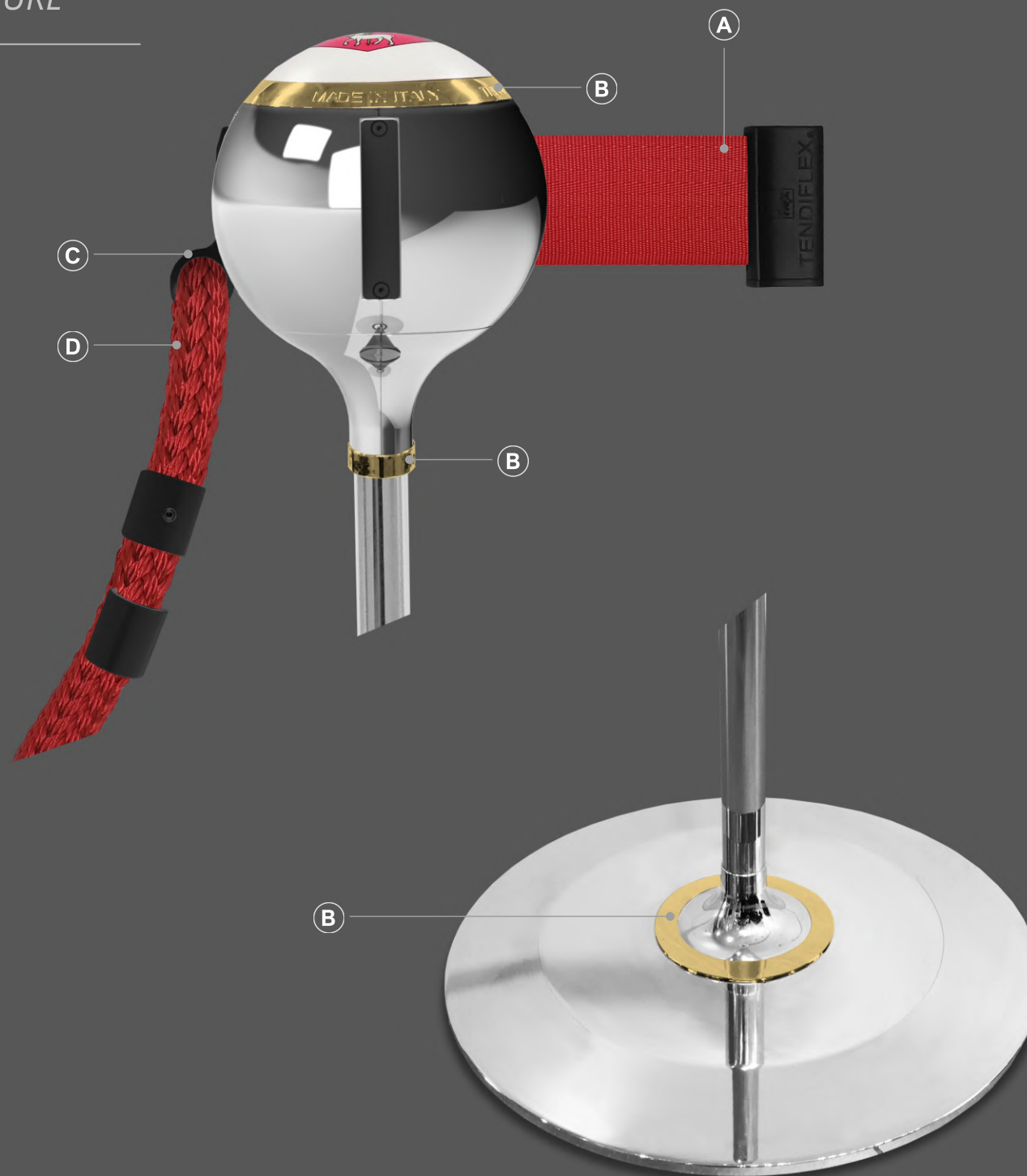
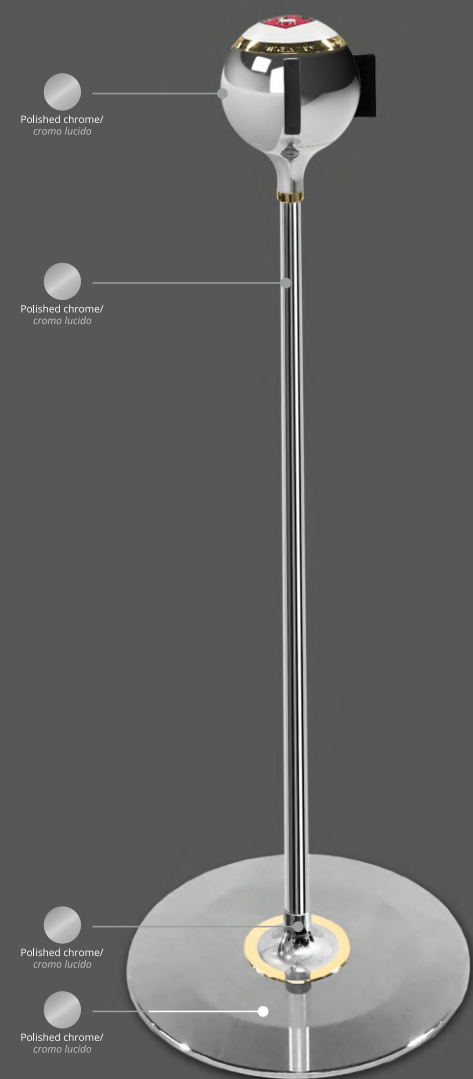

### A Webbing/ Nastro



### B Upper ring, collar ring and lover ring/ Anello superiore, anello collarino e anello inferiore



### C Magnetic terminal and block for cordon passage/ Terminale magnetico e blocchetto per passaggio cordone



### D Rope diameter 18 mm/ Cordone diametro 18 mm

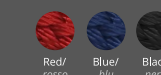

*Margherita*  
Model / Modello



## TENDIFLEX® SPHERE - FINISHES and COLORS/ TENDIFLEX® SPHERE - COLORI E FINITURE

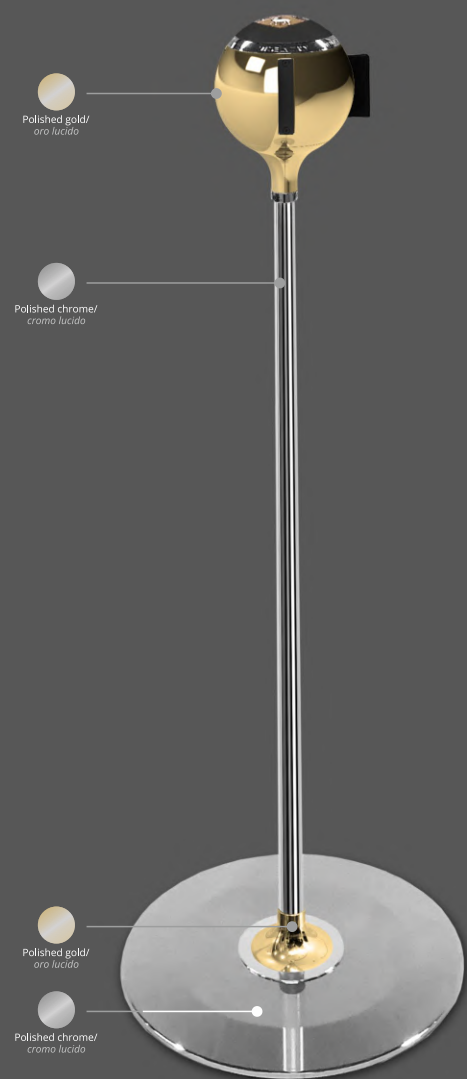

*Diletta*  
Model / Modello

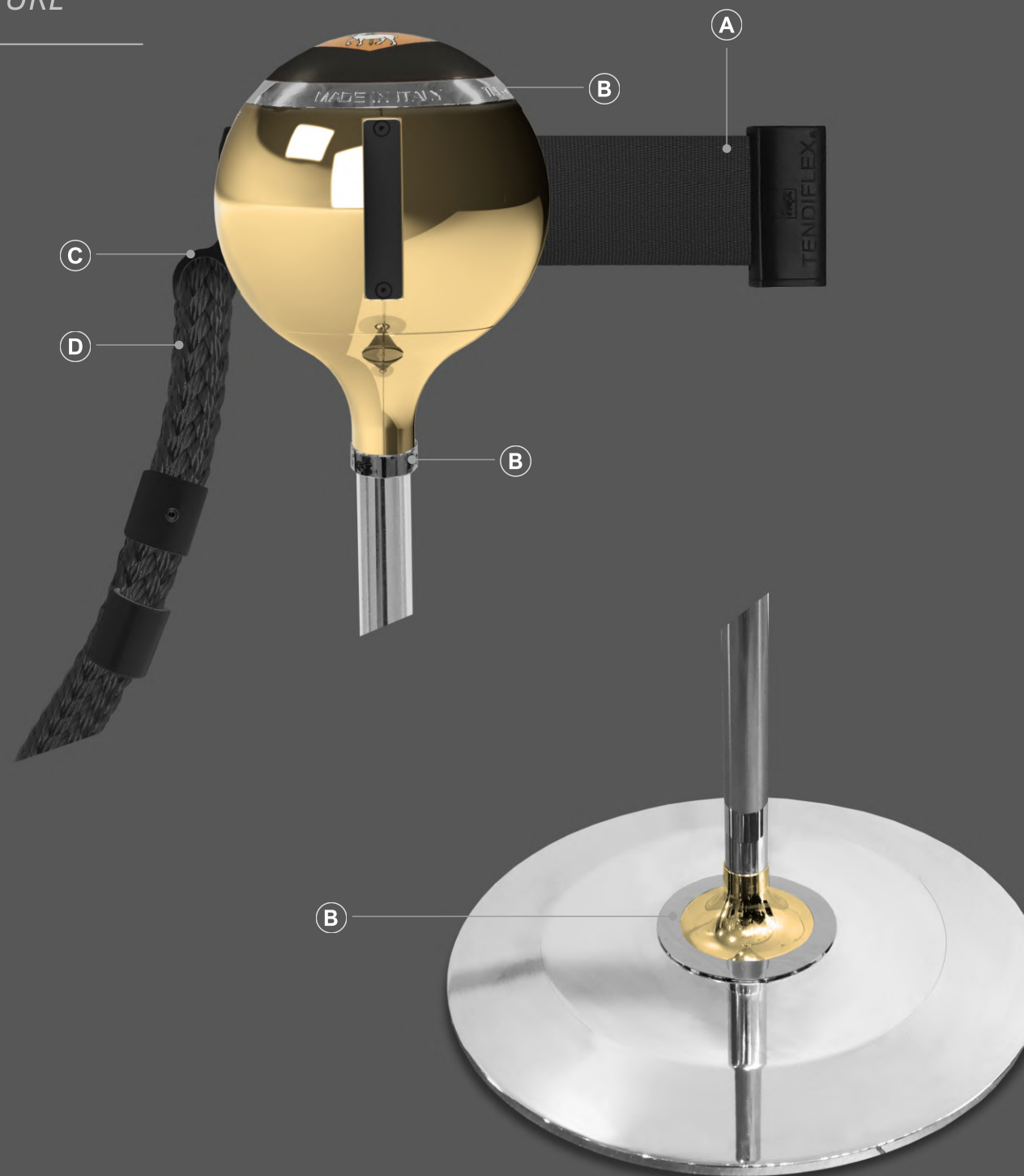

### COLORS and FINISHES AVAILABLE / COLORI e FINITURE DISPONIBILI

**A** Webbing/ Nastro

Red/ rosso	Green/ verde	Blue/ blu	Burgundy/ bordeaux	Neptune green/ verde nettuno	Yellow/ giallo	Brown/ marrone	Black/ nero	Grey/ grigio
Fluo Pink/ rosa fluo	Fluo green/ verde fluo	Fluo Yellow/ giallo fluo	Fluo orange/ arancio fluo	Custom colors/ colori personalizzati				

**B** Upper ring, collar ring and lover ring/  
*Anello superiore, anello collarino e anello inferiore*

Red/ rosso	Blue/ blu	Green/ verde	Yellow/ giallo	Black/ nero	White/ bianco	Fluo Yellow/ giallo fluo	Fluo Pink/ rosa fluo	Fluo orange/ arancio fluo	Fluo green/ verde fluo
Polished gold/ oro lucido	Polished chrome/ cromo lucido	Custom colors/ colori personalizzati							

**C** Magnetic terminal and block for cordon passage/  
*Terminale magnetico e blocchetto per passaggio cordone*

Black/ nero	White/ bianco
-------------	---------------

**D** Rope diameter 18 mm/ *Cordone diametro 18 mm*

Red/ rosso	Blue/ blu	Black/ nero
------------	-----------	-------------





## TENDIFLEX® SPHERE - FINISHES and COLORS/ TENDIFLEX® SPHERE - COLORI E FINITURE

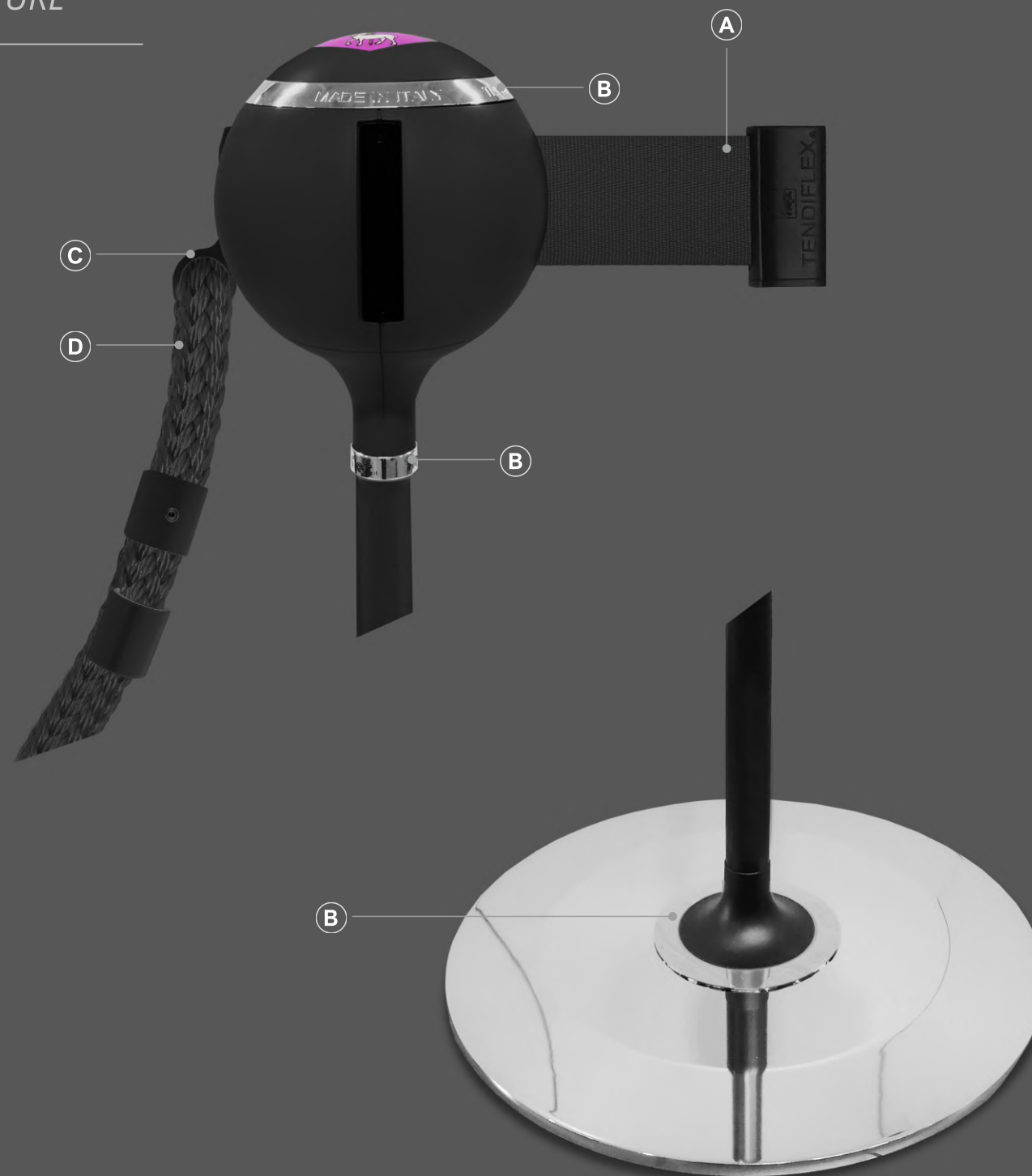
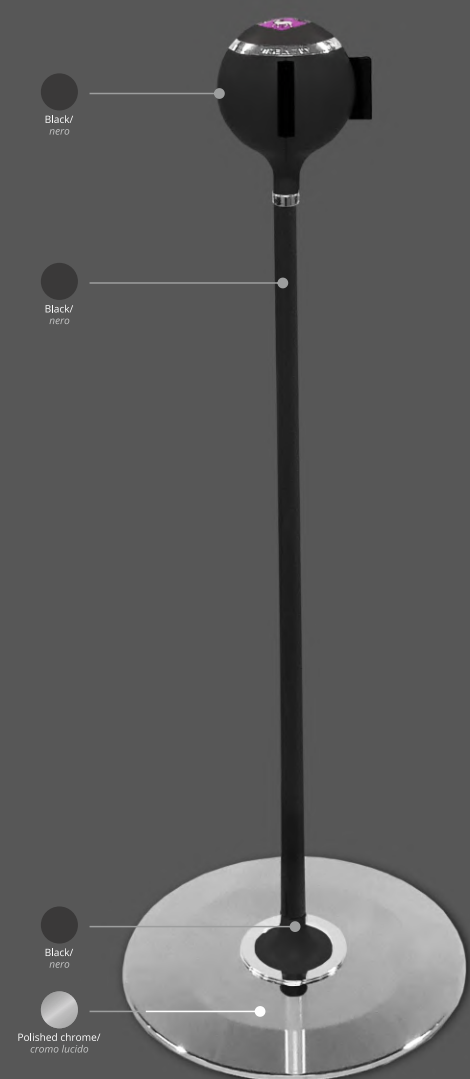

### COLORS and FINISHES AVAILABLE / COLORI e FINITURE DISPONIBILI

**A** Webbing/ Nastro

Red/rosso	Green/verde	Blue/blu	Burgundy/bordeaux	Neptune green/verde nettuno	Yellow/giallo	Brown/marrone	Black/nero	Grey/grigio
Fluo Pink/rosa fluo	Fluo green/verde fluo	Fluo Yellow/giallo fluo	Fluo orange/arancio fluo	Custom colors/colori personalizzati				

**B** Upper ring, collar ring and lover ring/  
*Anello superiore, anello collarino e anello inferiore*

Red/rosso	Blue/blu	Green/verde	Yellow/giallo	Black/nero	White/bianco	Fluo Yellow/giallo fluo	Fluo Pink/rosa fluo	Fluo orange/arancio fluo	Fluo green/verde fluo
Polished gold/oro lucido	Polished chrome/cromo lucido	Custom colors/colori personalizzati							

**C** Magnetic terminal and block for cordon passage/  
*Terminale magnetico e blocchetto per passaggio cordone*

Black/nero	White/bianco
------------	--------------

**D** Rope diameter 18 mm/ *Cordone diametro 18 mm*

Red/rosso	Blue/blu	Black/nero
-----------	----------	------------

*Claudia*  
Model / Modello





## TENDIFLEX® SPHERE - FINISHES and COLORS/ TENDIFLEX® SPHERE - COLORI E FINITURE

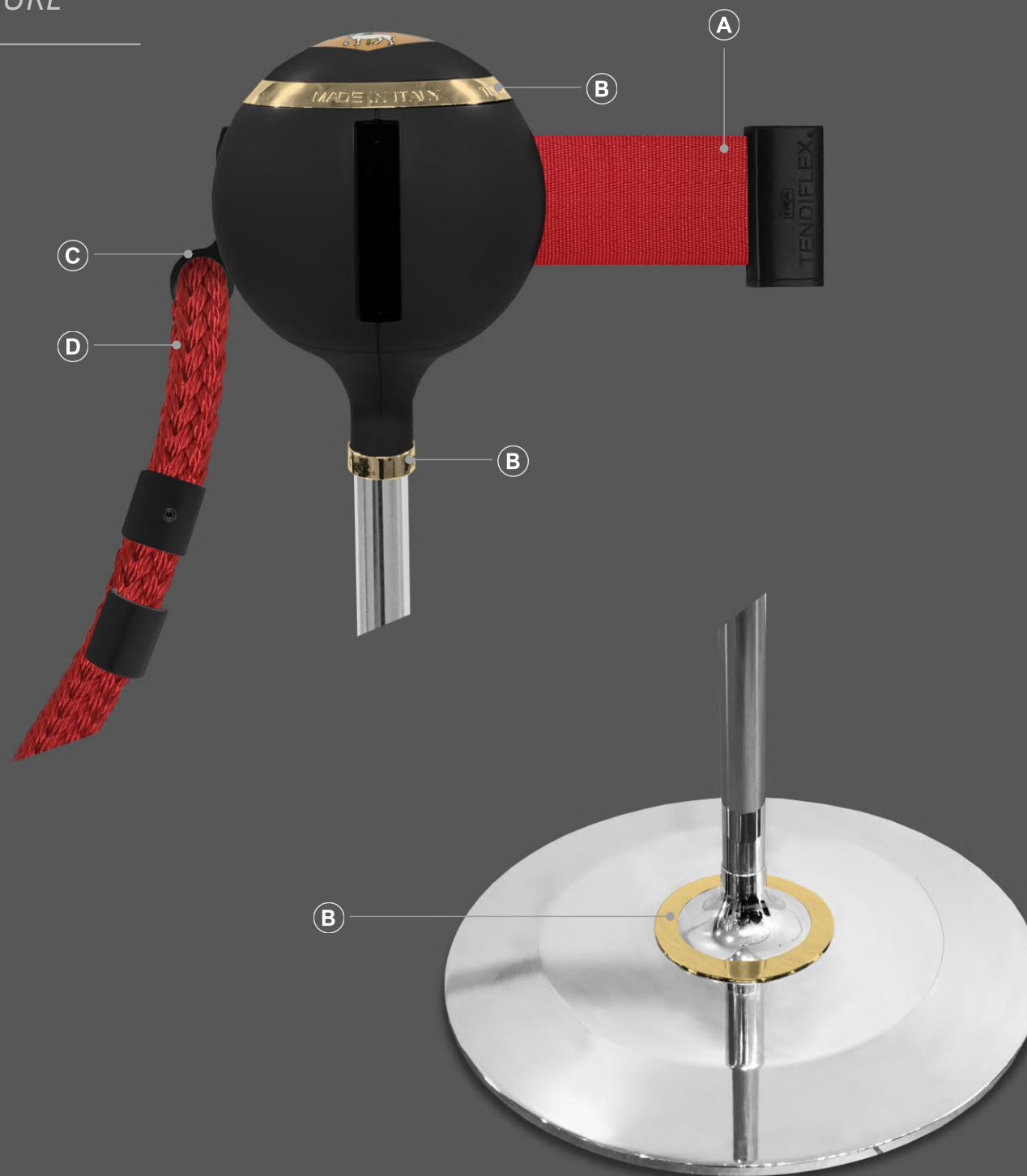
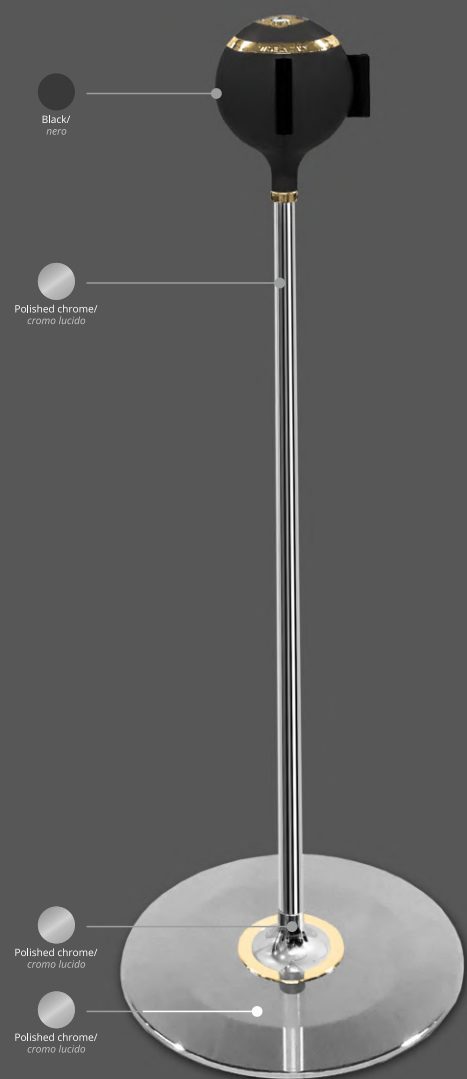

### COLORS and FINISHES AVAILABLE / COLORI e FINITURE DISPONIBILI

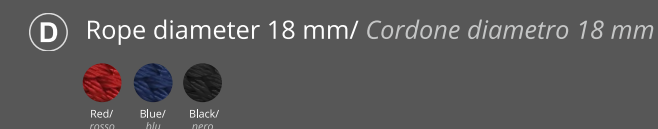
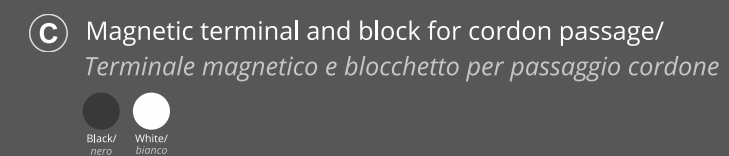

*Emma*  
Model / Modello



## TENDIFLEX® SPHERE - STANDARD FINISHES and COLORS/ TENDIFLEX® SPHERE - COLORI E FINITURE STANDARD

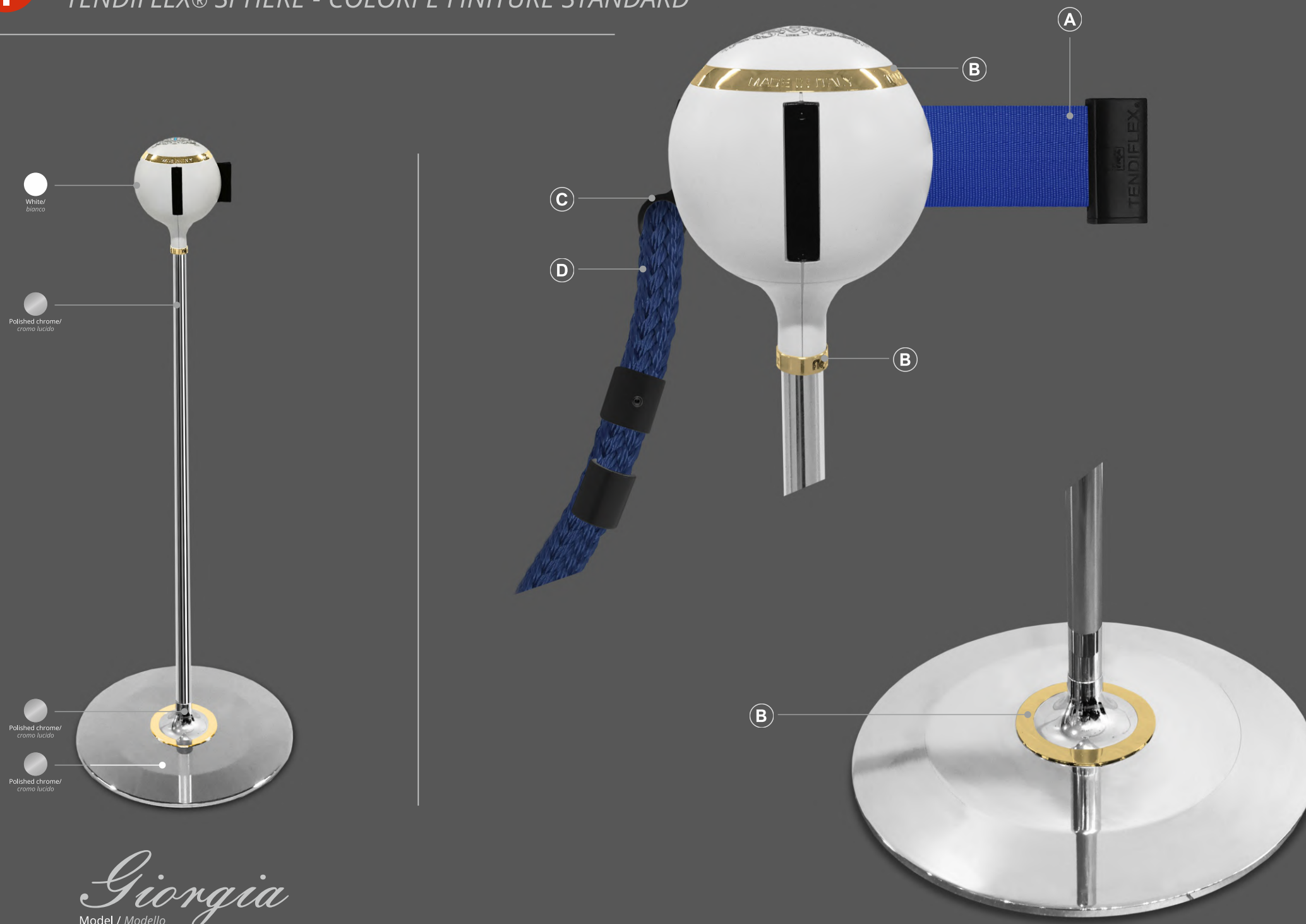

### COLORS and FINISHES AVAILABLE / COLORI e FINITURE DISPONIBILI

- A** Webbing/ Nastro
- |                         |                           |                             |                              |   |                   |                   |                |                 |
|-------------------------|---------------------------|-----------------------------|------------------------------|---|-------------------|-------------------|----------------|-----------------|
| Red/<br>rosso           | Green/<br>verde           | Blue/<br>blu                | Burgundy/<br>bordeaux        | Neptune green/<br>verde nettuno         | Yellow/<br>giallo | Brown/<br>marrone | Black/<br>nero | Grey/<br>grigio |
| Fluo Pink/<br>rosa fluo | Fluo green/<br>verde fluo | Fluo Yellow/<br>giallo fluo | Fluo orange/<br>arancio fluo | Custom colors/<br>colori personalizzati |                   |                   |                |                 |
- B** Upper ring, collar ring and lover ring/  
*Anello superiore, anello collarino e anello inferiore*
- |                              |                                  |   |                   |                |                  |                             |                         |                              |                           |
|------------------------------|----------------------------------|---|-------------------|----------------|------------------|-----------------------------|-------------------------|------------------------------|---------------------------|
| Red/<br>rosso                | Blue/<br>blu                     | Green/<br>verde                         | Yellow/<br>giallo | Black/<br>nero | White/<br>bianco | Fluo Yellow/<br>giallo fluo | Fluo Pink/<br>rosa fluo | Fluo orange/<br>arancio fluo | Fluo green/<br>verde fluo |
| Polished gold/<br>oro lucido | Polished chrome/<br>cromo lucido | Custom colors/<br>colori personalizzati |                   |                |                  |                             |                         |                              |                           |
- C** Magnetic terminal and block for cordon passage/  
*Terminale magnetico e blocchetto per passaggio cordone*
- |                |                  |
|----------------|------------------|
| Black/<br>nero | White/<br>bianco |
|----------------|------------------|
- D** Rope diameter 18 mm/ *Cordone diametro 18 mm*
- |               |              |                |
|---------------|--------------|----------------|
| Red/<br>rosso | Blue/<br>blu | Black/<br>nero |
|---------------|--------------|----------------|

*Giorgia*  
Model / Modello



## TENDIFLEX® SPHERE - FINISHES and COLORS/ TENDIFLEX® SPHERE - COLORI E FINITURE

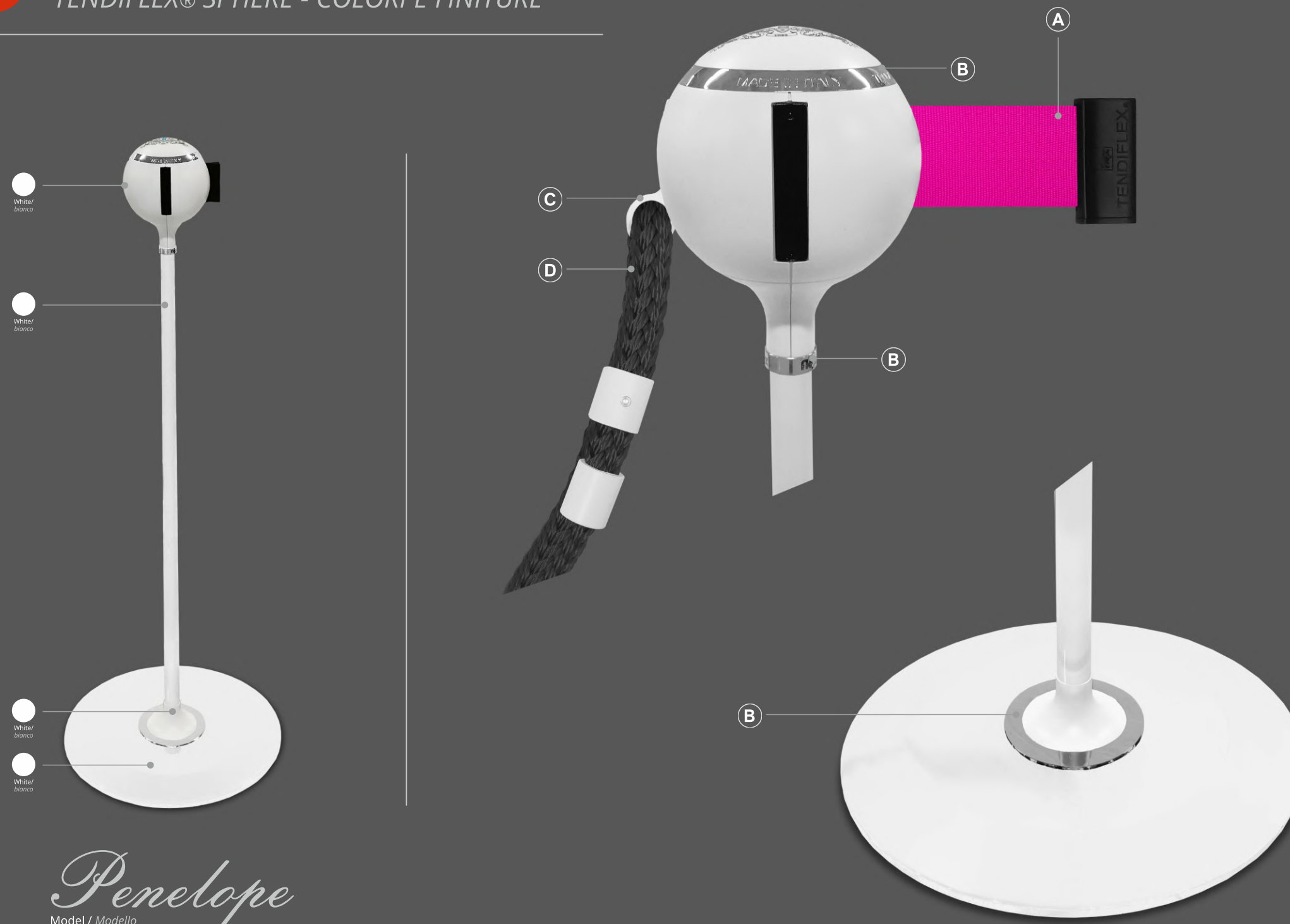

### COLORS and FINISHES AVAILABLE / COLORI e FINITURE DISPONIBILI

**A** Webbing/ Nastro

Red/ rosso	Green/ verde	Blue/ blu	Burgundy/ bordeaux	Neptune green/ verde nettuno	Yellow/ giallo	Brown/ marrone	Black/ nero	Grey/ grigio
Fluo Pink/ rosa fluo	Fluo green/ verde fluo	Fluo Yellow/ giallo fluo	Fluo orange/ arancio fluo	Custom colors/ colori personalizzati				

**B** Upper ring, collar ring and lover ring/  
*Anello superiore, anello collarino e anello inferiore*

Red/ rosso	Blue/ blu	Green/ verde	Yellow/ giallo	Black/ nero	White/ bianco	Fluo Yellow/ giallo fluo	Fluo Pink/ rosa fluo	Fluo orange/ arancio fluo	Fluo green/ verde fluo
Polished gold/ oro lucido	Polished chrome/ cromo lucido	Custom colors/ colori personalizzati							

**C** Magnetic terminal and block for cordon passage/  
*Terminale magnetico e blocchetto per passaggio cordone*

Black/ nero	White/ bianco
----------------	------------------

**D** Rope diameter 18 mm/ *Cordone diametro 18 mm*

Red/ rosso	Blue/ blu	Black/ nero
---------------	--------------	----------------

*Penelope*  
Model / Modello



**TENDIFLEX® SPHERE - FINISHES and COLORS/**  
*TENDIFLEX® SPHERE - COLORI E FINITURE*

COLORS and FINISHES AVAILABLE / *COLORI e FINITURE DISPONIBILI*

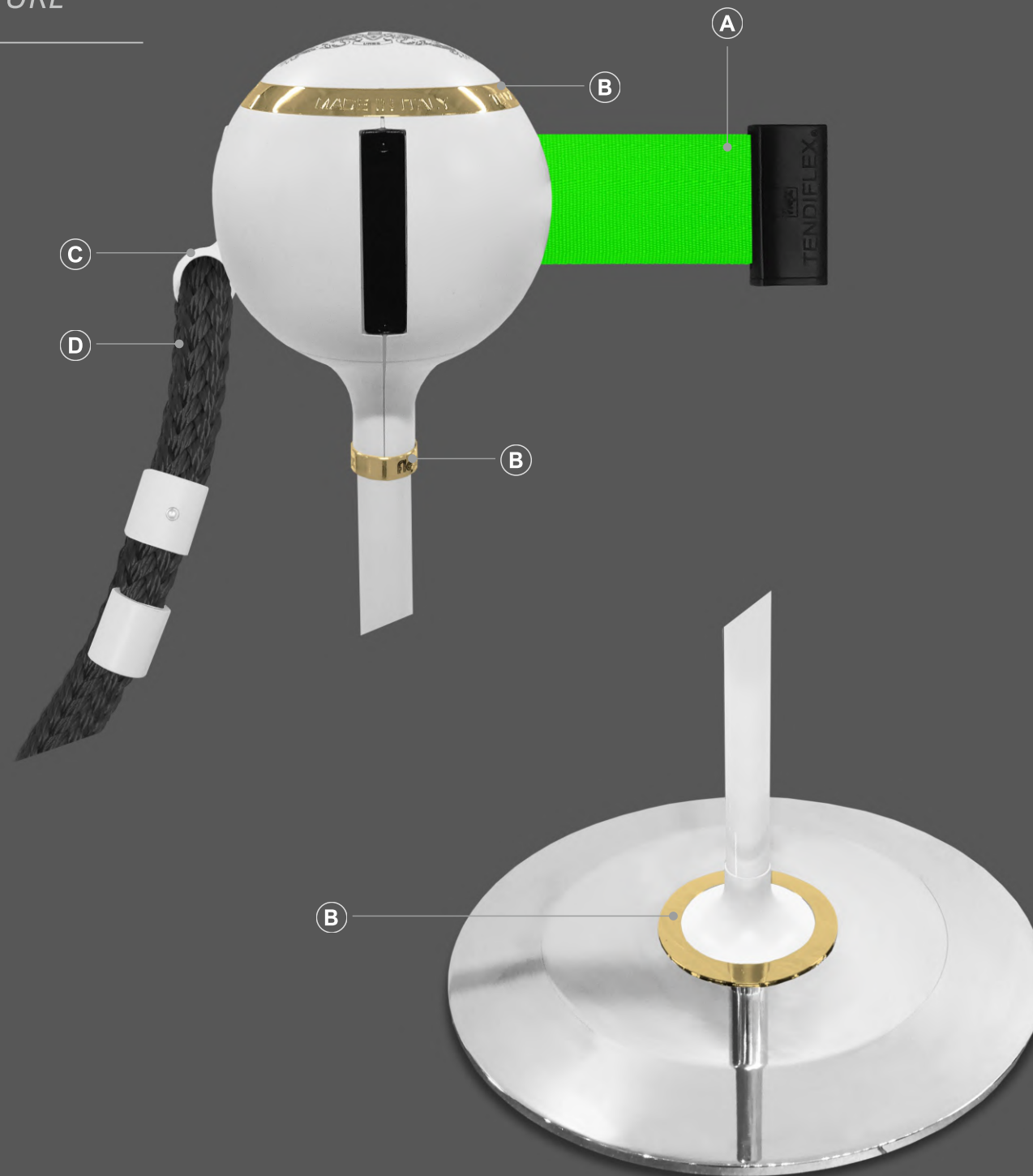
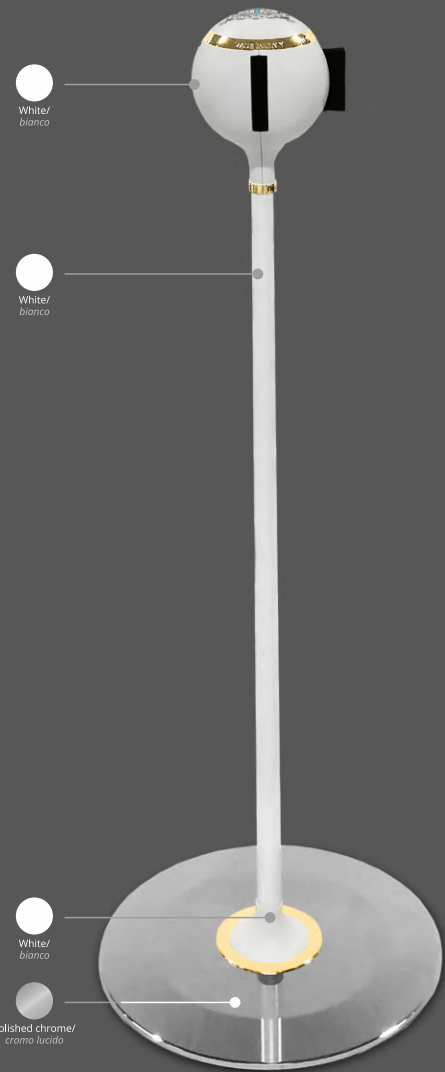

**A** Webbing/ Nastro



**B** Upper ring, collar ring and lover ring/

*Anello superiore, anello collarino e anello inferiore*



**C** Magnetic terminal and block for cordon passage/

*Terminale magnetico e blocchetto per passaggio cordone*

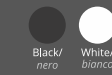

**D** Rope diameter 18 mm/ *Cordone diametro 18 mm*



*Rebecca*  
Model / Modello





## TENDIFLEX® SPHERE - FINISHES and COLORS/ TENDIFLEX® SPHERE - COLORI E FINITURE

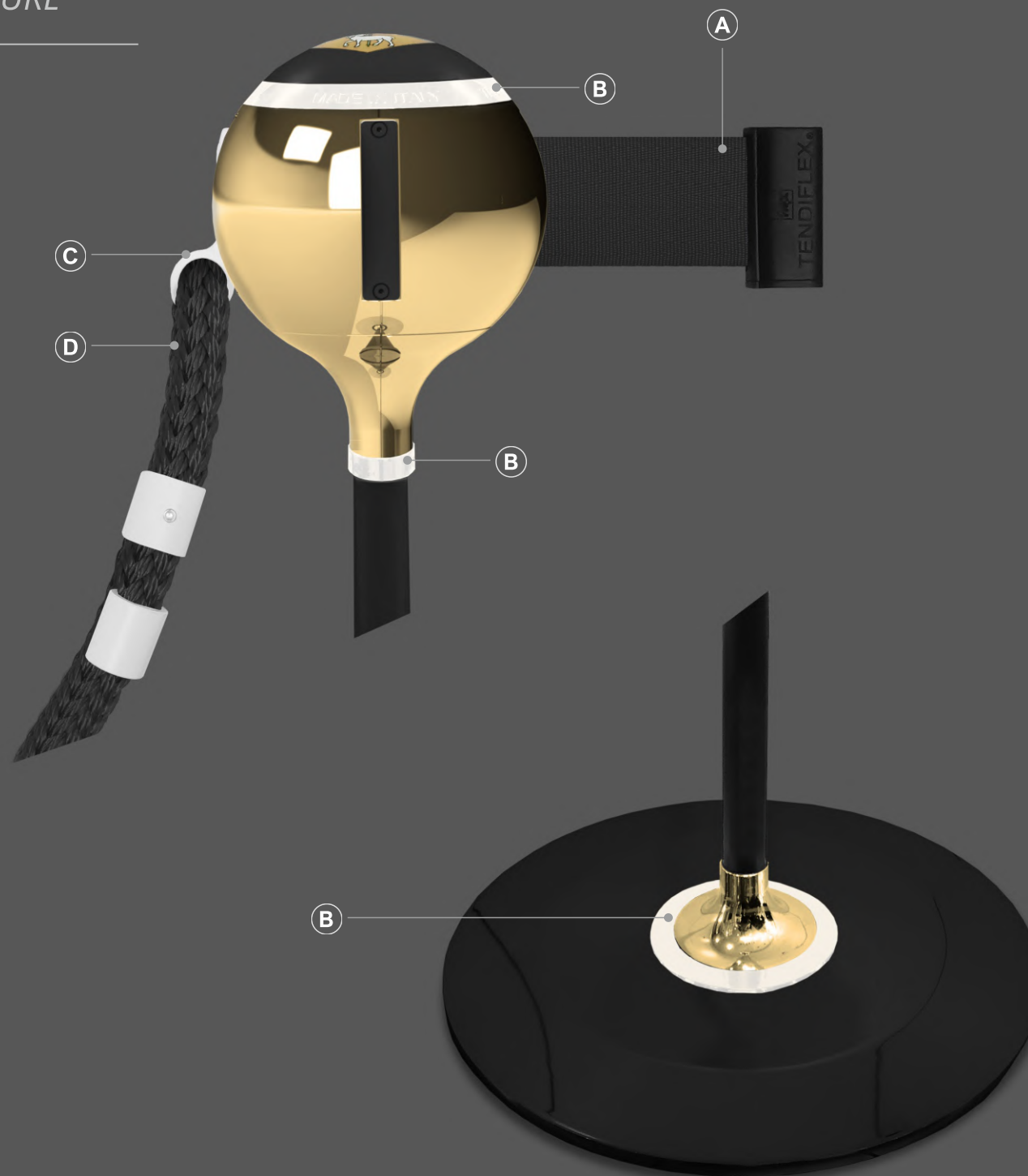
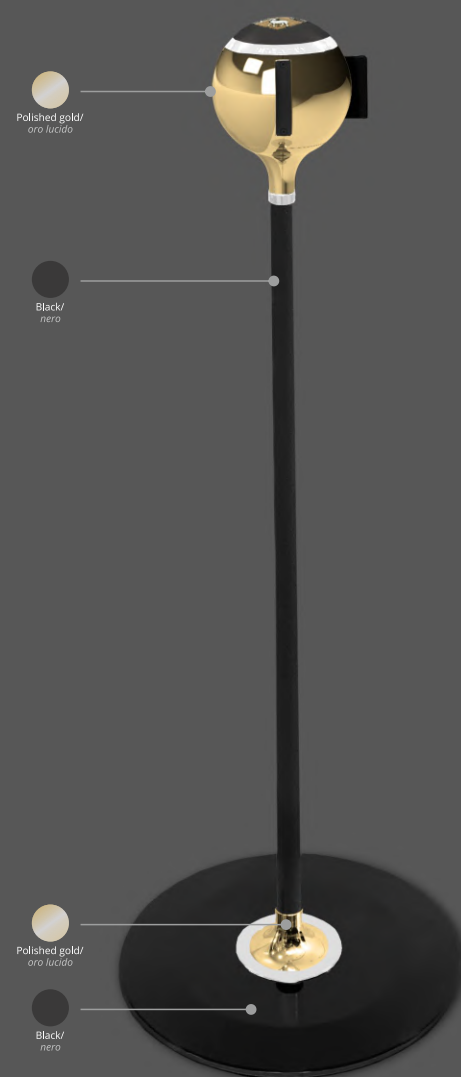

### COLORS and FINISHES AVAILABLE / COLORI e FINITURE DISPONIBILI

**A** Webbing/ Nastro

Red/ rosso	Green/ verde	Blue/ blu	Burgundy/ bordeaux	Neptune green/ verde nettuno	Yellow/ giallo	Brown/ marrone	Black/ nero	Grey/ grigio
Fluo Pink/ rosa fluo	Fluo green/ verde fluo	Fluo Yellow/ giallo fluo	Fluo orange/ arancio fluo	Custom colors/ colori personalizzati				

**B** Upper ring, collar ring and lover ring/  
*Anello superiore, anello collarino e anello inferiore*

Red/ rosso	Blue/ blu	Green/ verde	Yellow/ giallo	Black/ nero	White/ bianco	Fluo Yellow/ giallo fluo	Fluo Pink/ rosa fluo	Fluo orange/ arancio fluo	Fluo green/ verde fluo
Polished gold/ oro lucido	Polished chrome/ cromo lucido	Custom colors/ colori personalizzati							

**C** Magnetic terminal and block for cordon passage/  
*Terminale magnetico e blocchetto per passaggio cordone*

Black/ nero	White/ bianco
----------------	------------------

**D** Rope diameter 18 mm/ *Cordone diametro 18 mm*

Red/ rosso	Blue/ blu	Black/ nero
---------------	--------------	----------------

*Regina*  
Model / Modello



## TENDIFLEX® SPHERE - FINISHES and COLORS/ TENDIFLEX® SPHERE - COLORI E FINITURE



### COLORS and FINISHES AVAILABLE / COLORI e FINITURE DISPONIBILI

**A** Webbing/ Nastro

Red/ rosso	Green/ verde	Blue/ blu	Burgundy/ bordeaux	Neptune green/ verde nettuno	Yellow/ giallo	Brown/ marrone	Black/ nero	Grey/ grigio
Fluo Pink/ rosa fluo	Fluo green/ verde fluo	Fluo Yellow/ giallo fluo	Fluo orange/ arancio fluo	Custom colors/ colori personalizzati				

**B** Upper ring, collar ring and lover ring/  
*Anello superiore, anello collarino e anello inferiore*

Red/ rosso	Blue/ blu	Green/ verde	Yellow/ giallo	Black/ nero	White/ bianco	Fluo Yellow/ giallo fluo	Fluo Pink/ rosa fluo	Fluo orange/ arancio fluo	Fluo green/ verde fluo
Polished gold/ oro lucido	Polished chrome/ cromo lucido	Custom colors/ colori personalizzati							

**C** Magnetic terminal and block for cordon passage/  
*Terminale magnetico e blocchetto per passaggio cordone*

Black/ nero	White/ bianco
----------------	------------------

**D** Rope diameter 18 mm/ *Cordone diametro 18 mm*

Red/ rosso	Blue/ blu	Black/ nero
---------------	--------------	----------------

*Sofia*  
Model / Modello



## EXAMPLES OF CUSTOMIZATION - RETAIL/ ESEMPI DI PERSONALIZZAZIONE - VENDITA AL DETTAGLIO

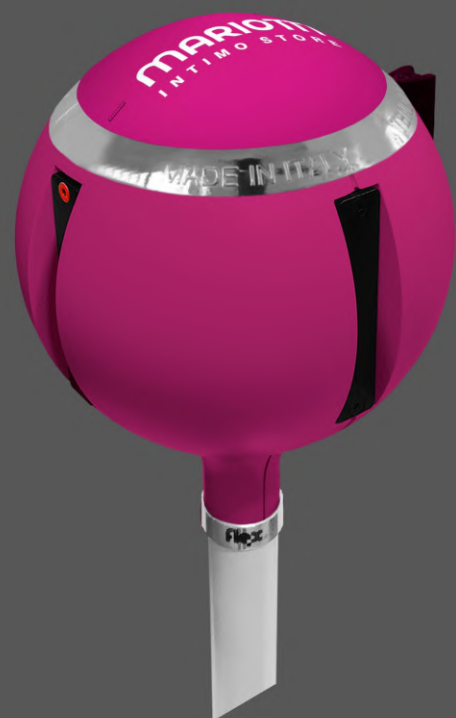

Magenta - RAL 4010/  
magenta - RAL 4010



Green Yellow - RAL 6018/  
verde giallo - RAL 6018



Fire red - RAL 3000/  
rosso fuoco - RAL 3000



Signal blue - RAL 5005/  
blu segnale - RAL 5005



Zinc yellow - RAL 1018/  
giallo zinco - RAL 1018

All logos and brands represented in this catalogue are used by way of example only and shall not be considered exploited for commercial and advertising purposes. We apologize for any misinterpretation and inconvenience that may occur.

*I loghi e i marchi rappresentati in questo catalogo vengono utilizzati solo a titolo esemplificativo e non devono intendersi sfruttati per fini commerciali e pubblicitari. Ci scusiamo per qualsiasi errore di interpretazione ed inconveniente che possa verificarsi.*



## EXAMPLES OF CUSTOMIZATION - TRANSPORT SERVICES and COMPANY/ ESEMPI DI PERSONALIZZAZIONE - TRASPORTI e AZIENDE

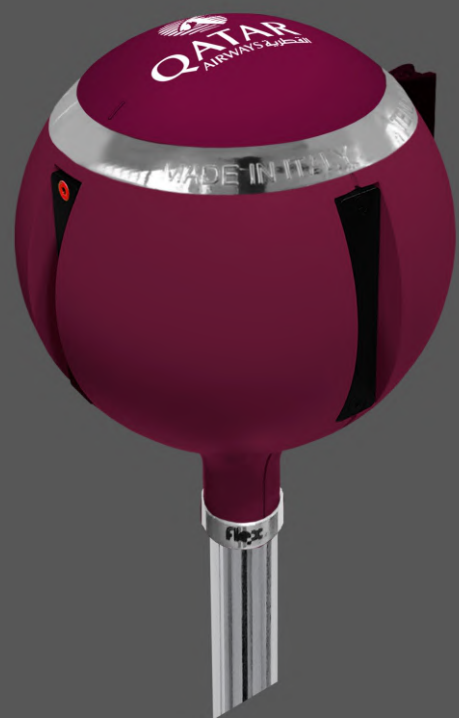

Burgundy purple - RAL 4004/  
viola bordeaux - RAL 4004

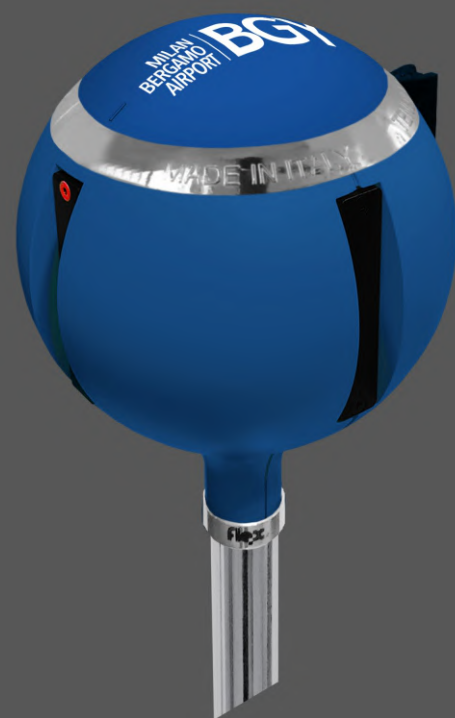

Signal blue - RAL 5005/  
blu segnale - RAL 5005



Walnut brown - RAL 8011/  
marrone noce - RAL 8011



Orange red - RAL 2008/  
arancio rosso - RAL 2008



Light pink - RAL 3015/  
rosa chiaro - RAL 3015

All logos and brands represented in this catalogue are used by way of example only and shall not be considered exploited for commercial and advertising purposes. We apologize for any misinterpretation and inconvenience that may occur.

*I loghi e i marchi rappresentati in questo catalogo vengono utilizzati solo a titolo esemplificativo e non devono intendersi sfruttati per fini commerciali e pubblicitari. Ci scusiamo per qualsiasi errore di interpretazione ed inconveniente che possa verificarsi.*





## EXAMPLES OF CUSTOMIZATION - SPORT and CHAMPAGNE COMPANIES/ ESEMPI DI PERSONALIZZAZIONE - SPORT e AZIENDE di CHAMPAGNE

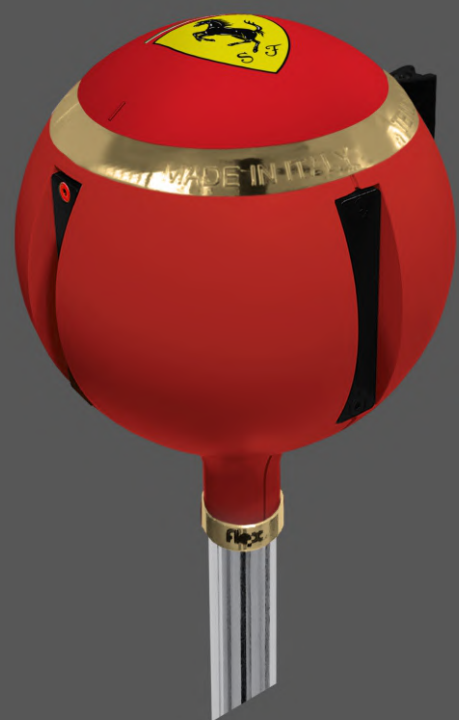

Signal red - RAL 3001/  
rosso segnale - RAL 3001

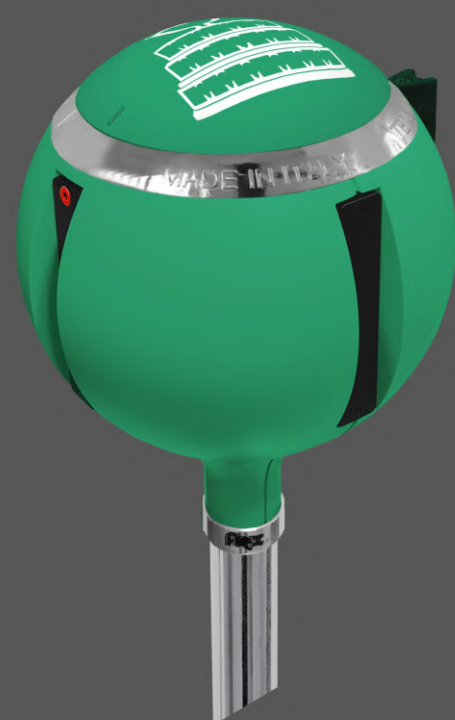

Turquoise blue - RAL 5018/  
blu turchese - RAL 5018

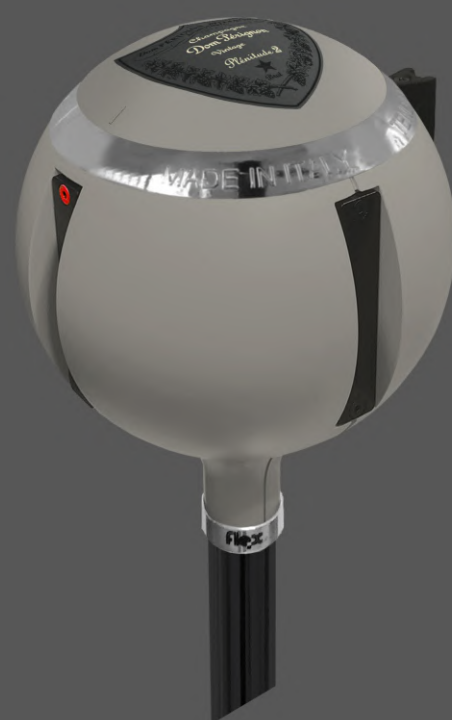

Siliceous grey - RAL 7032/  
grigio siliceo - RAL 7032



Signal red - RAL 3001/  
rosso segnale - RAL 3001

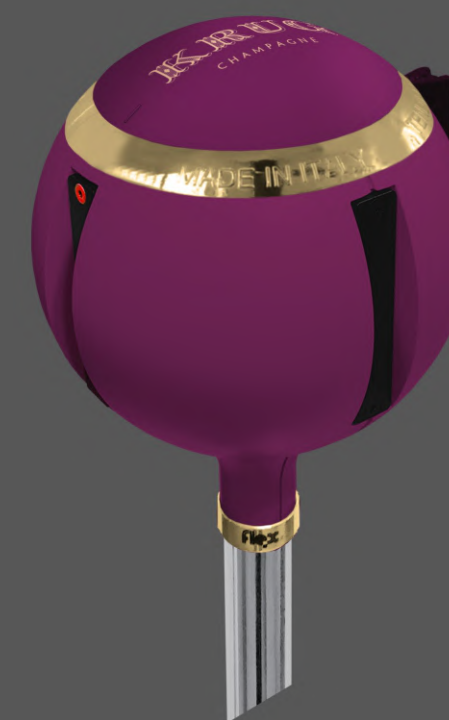

Traffic purple - RAL 4006/  
porpora traffico - RAL 4006

All logos and brands represented in this catalogue are used by way of example only and shall not be considered exploited for commercial and advertising purposes. We apologize for any misinterpretation and inconvenience that may occur.

*I loghi e i marchi rappresentati in questo catalogo vengono utilizzati solo a titolo esemplificativo e non devono intendersi sfruttati per fini commerciali e pubblicitari. Ci scusiamo per qualsiasi errore di interpretazione ed inconveniente che possa verificarsi.*



## TENDIFLEX® SPHERE - FINISHES and COLORS/ TENDIFLEX® SPHERE - COLORI E FINITURE



Model / Modello:

*Pink and Green*

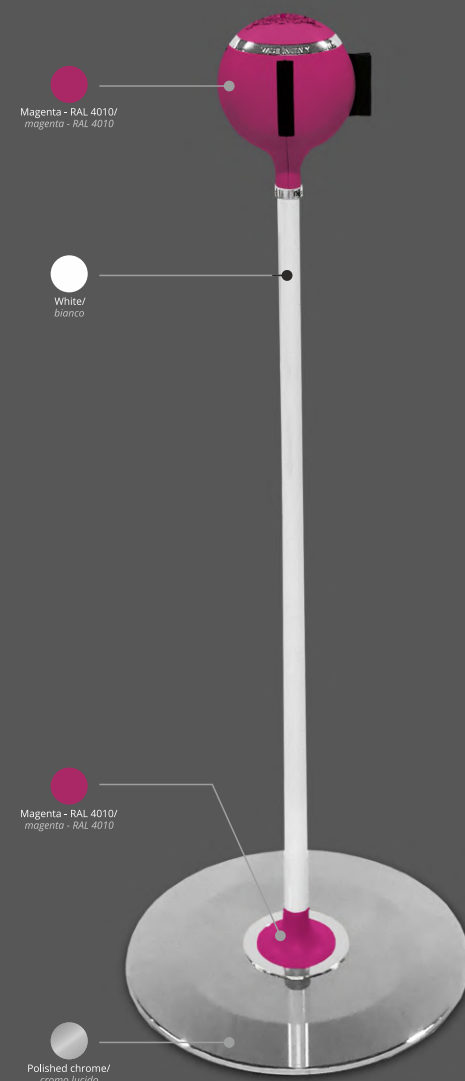

A

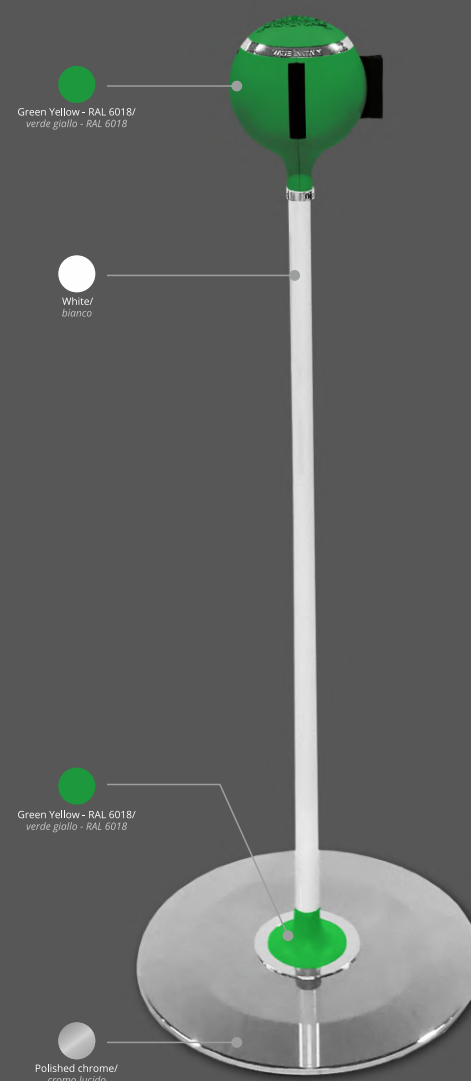

B

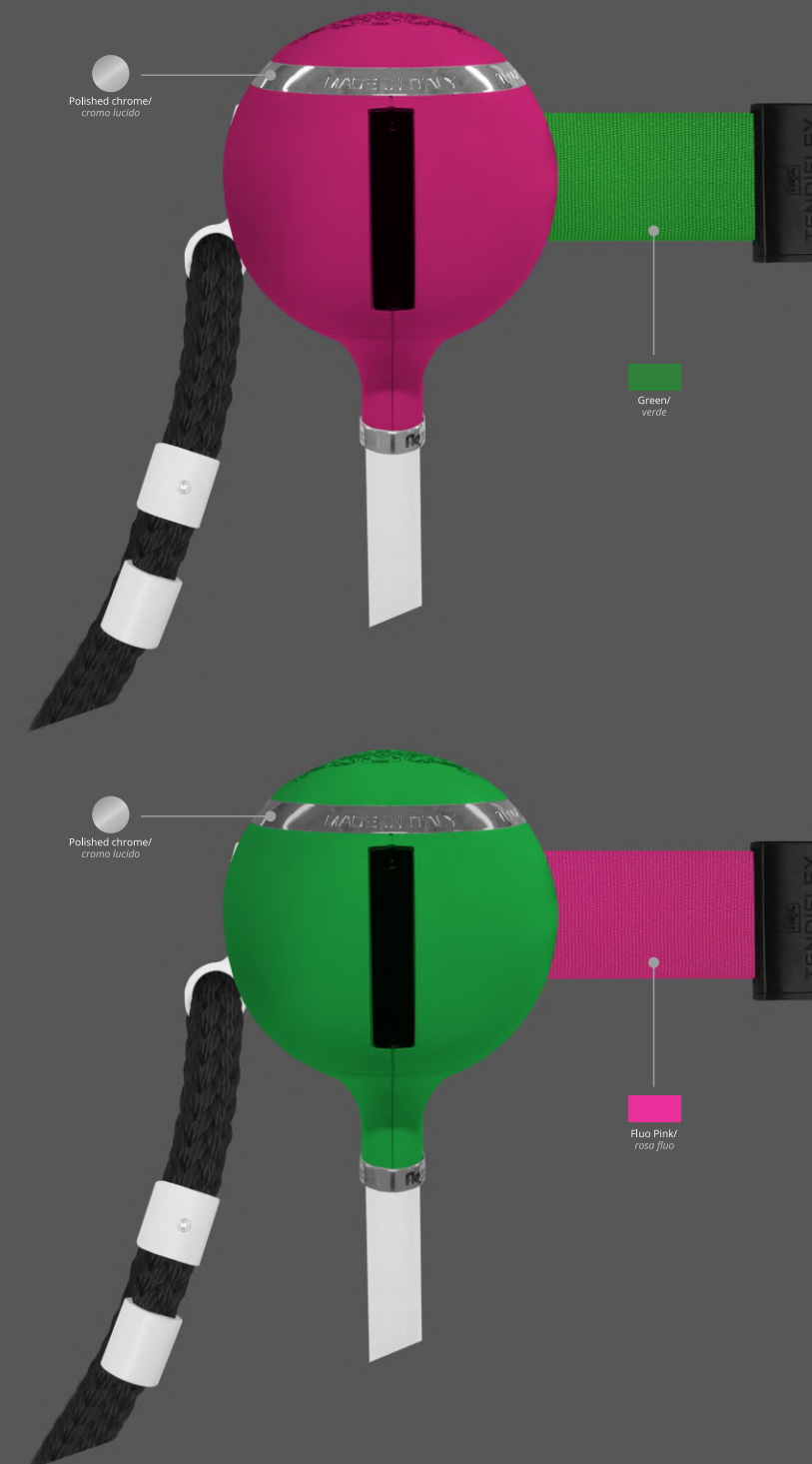

A

B





**TENDIFLEX® SPHERE - FINISHES and COLORS/**  
*TENDIFLEX® SPHERE - COLORI E FINITURE*

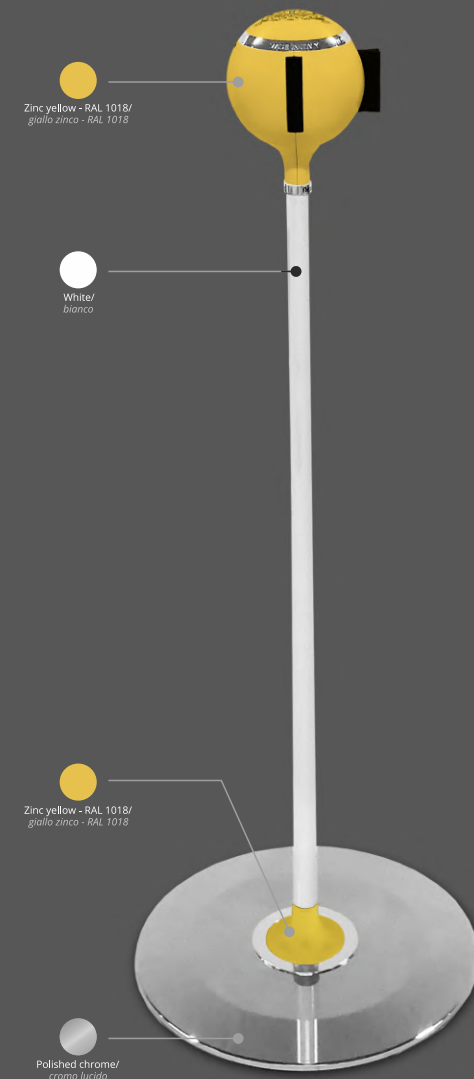

A



B

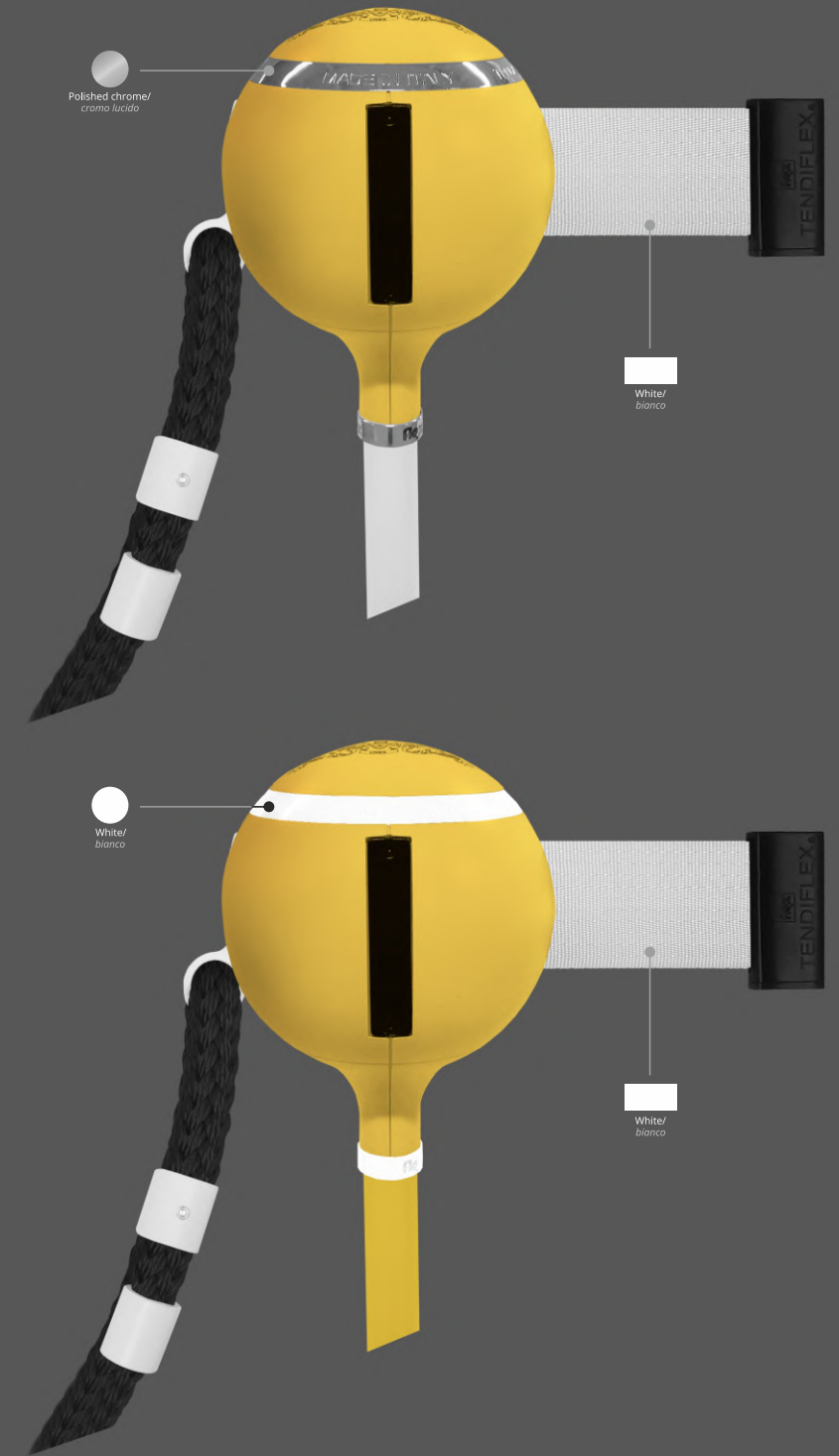

A

B



## TENDIFLEX® SPHERE - FINISHES and COLORS/ TENDIFLEX® SPHERE - COLORI E FINITURE

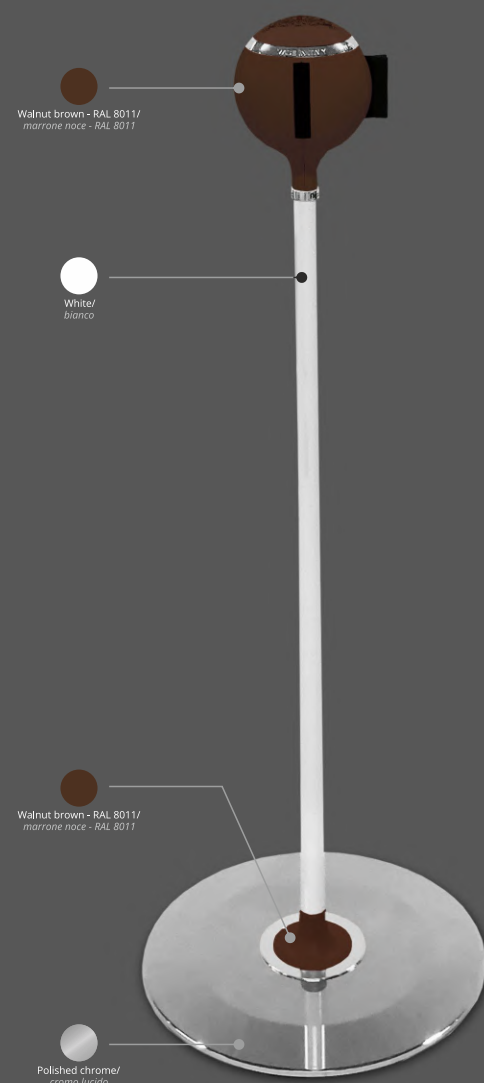

A

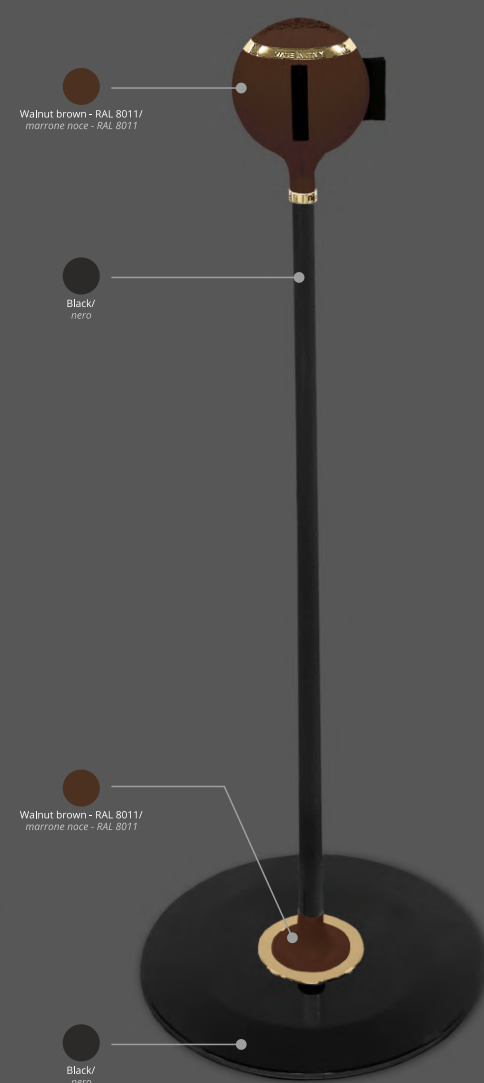

B

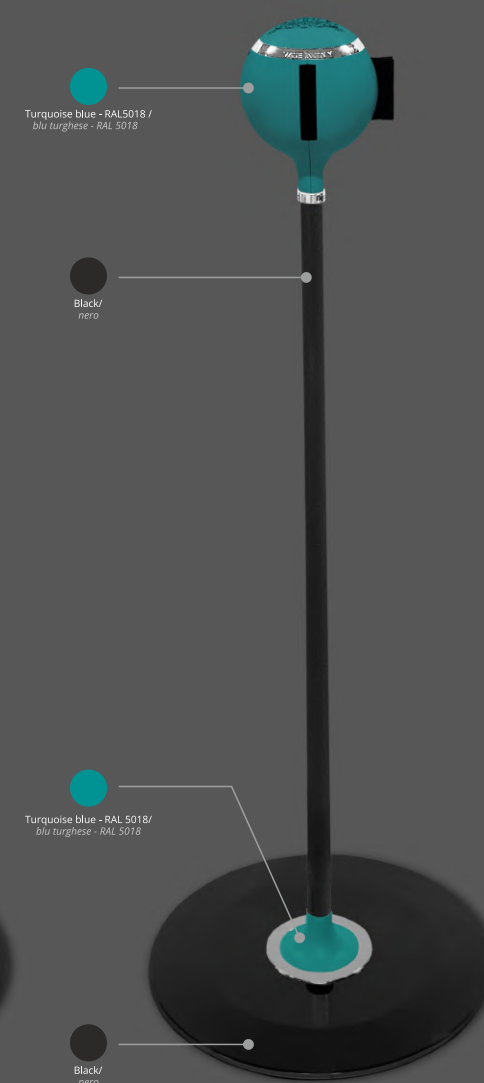

C

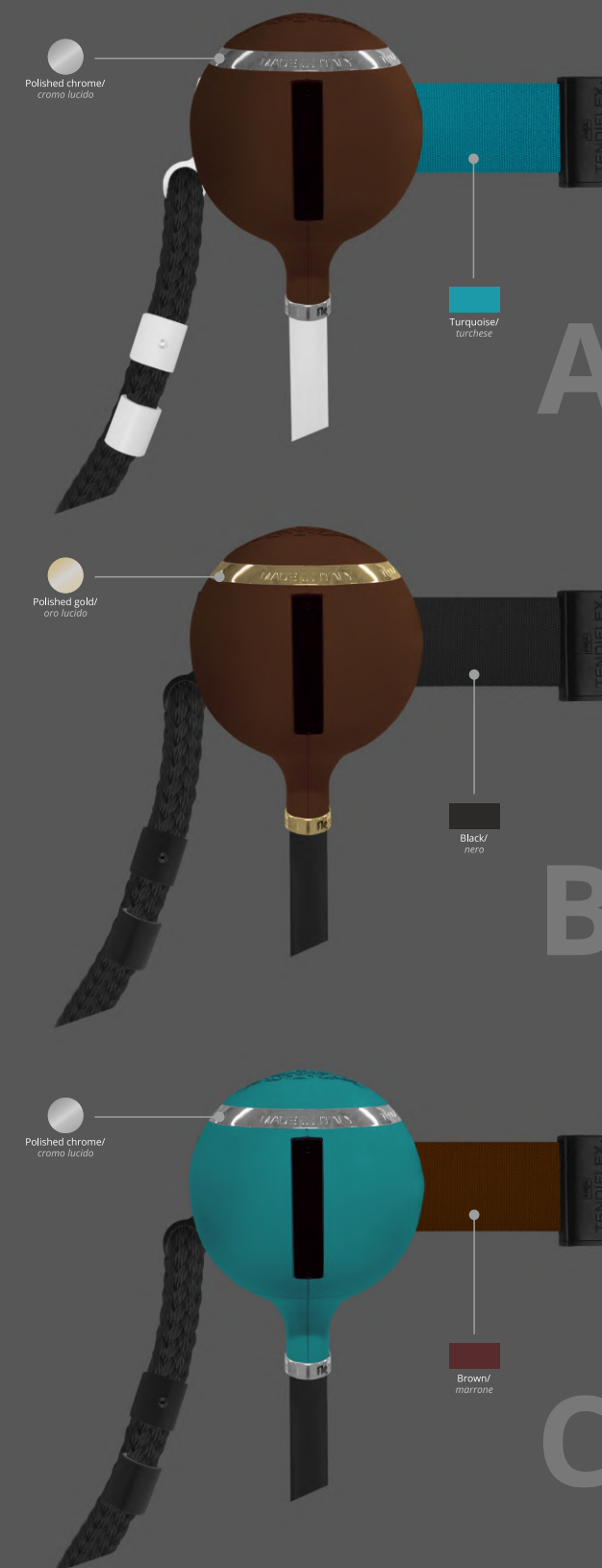

A

B

C





**TENDIFLEX® SPHERE - FINISHES and COLORS/**  
*TENDIFLEX® SPHERE - COLORI E FINITURE*

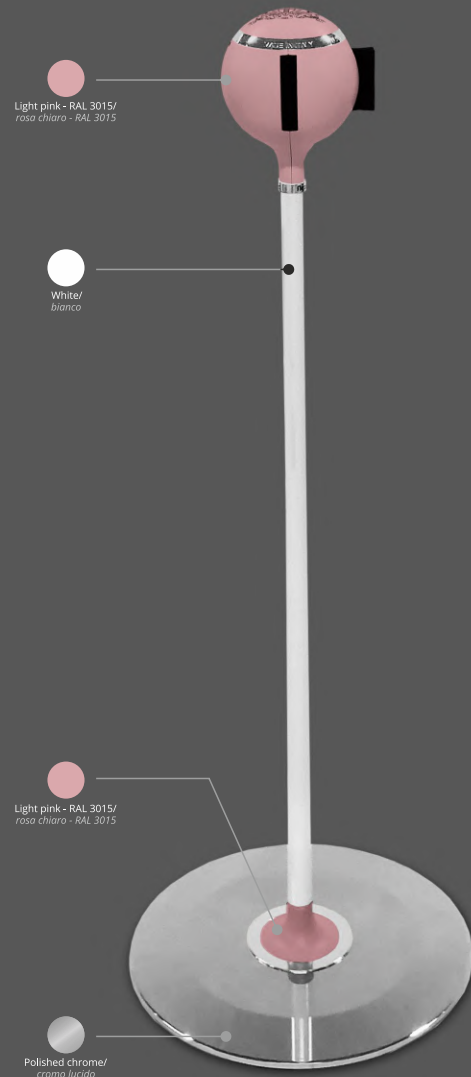

A

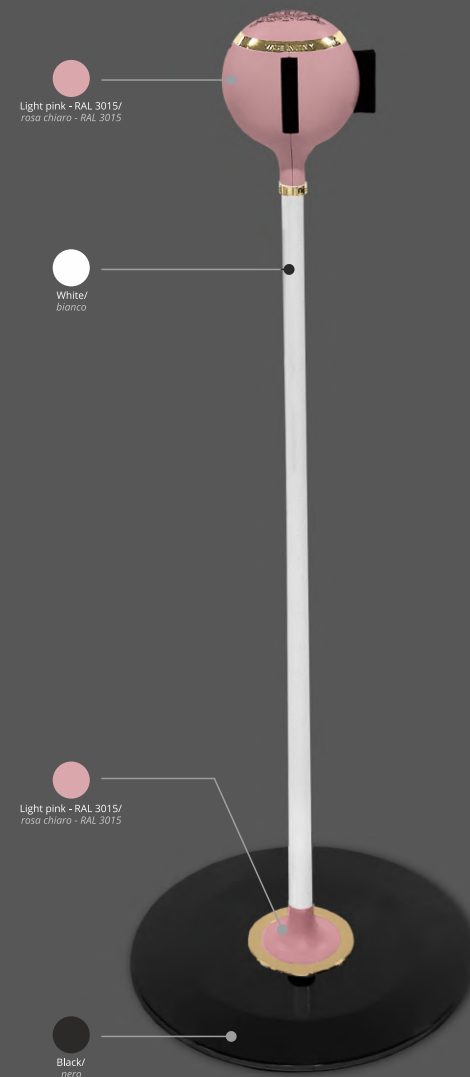

B

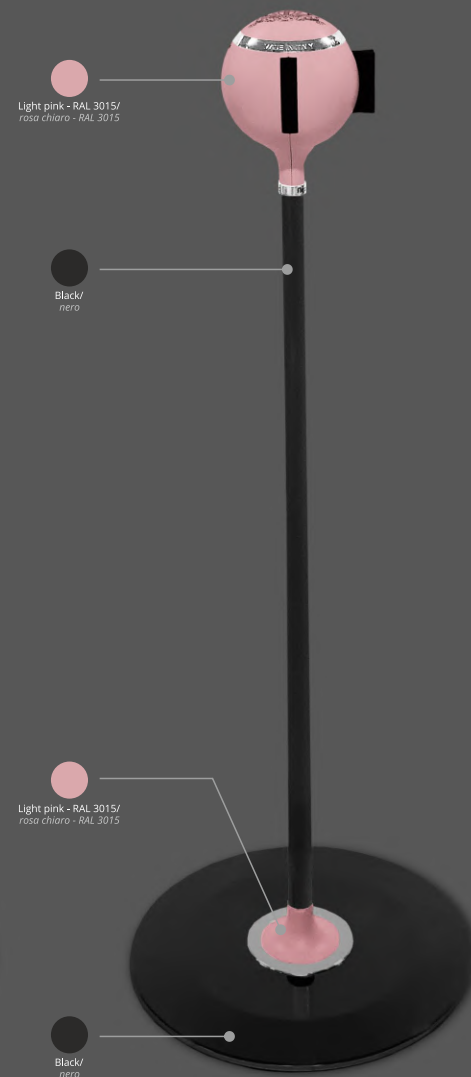

C

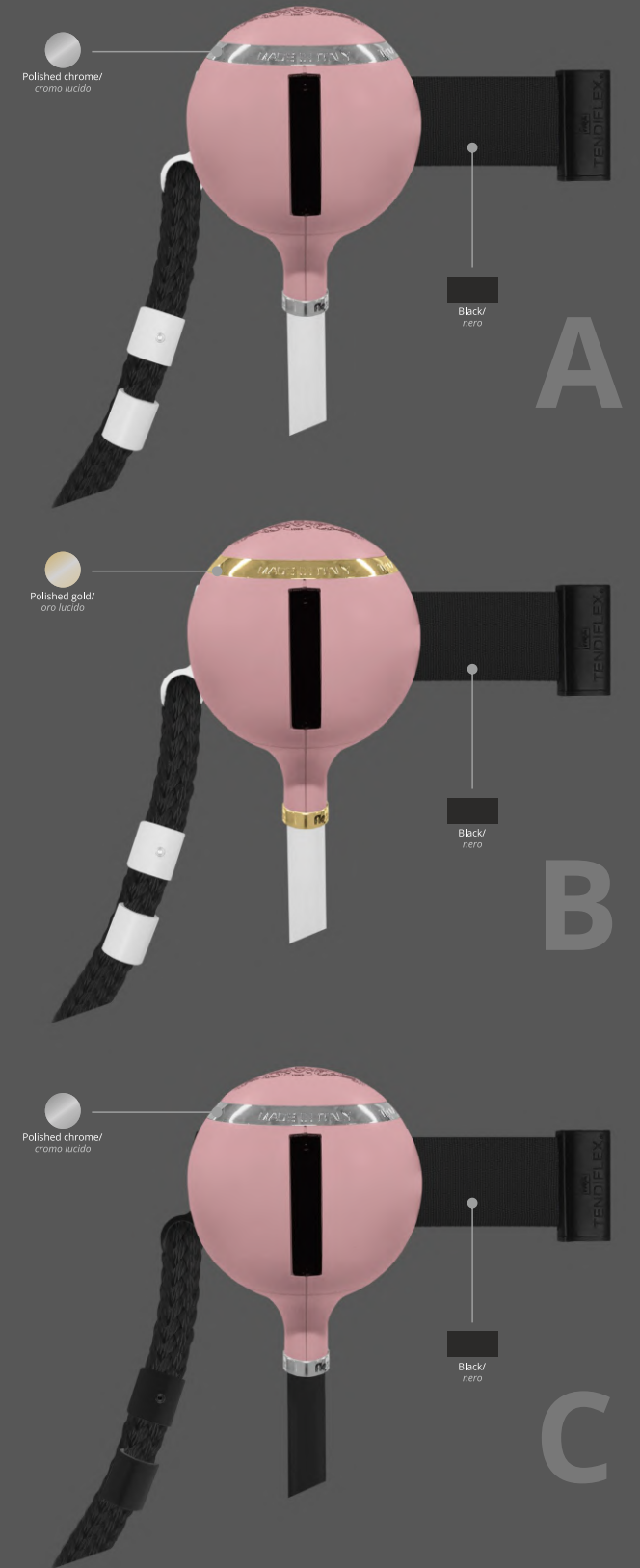

A

B

C



## TENDIFLEX® SPHERE - FINISHES and COLORS/ TENDIFLEX® SPHERE - COLORI E FINITURE



Model / Modello:

*Green Kale*

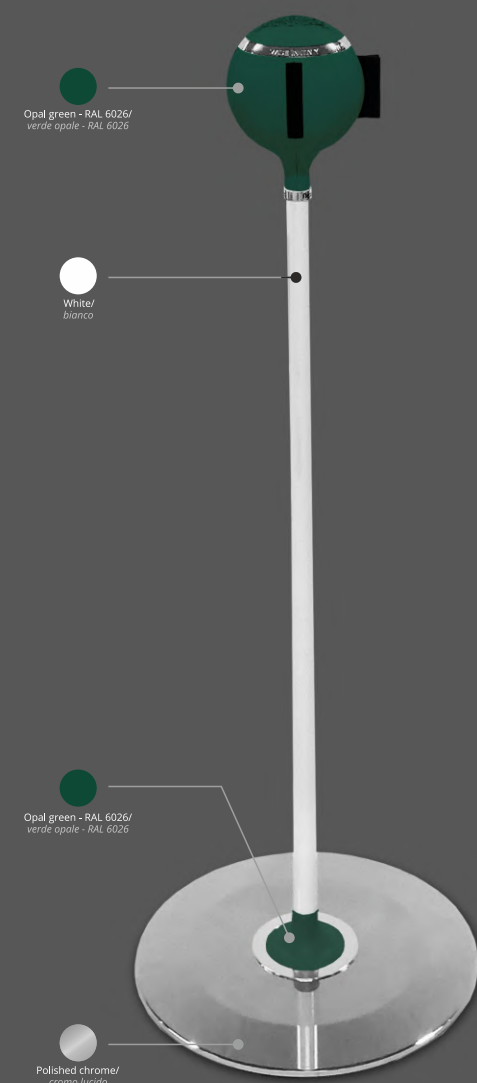

A



B



A

B





## TENDIFLEX® SPHERE - FINISHES and COLORS/ TENDIFLEX® SPHERE - COLORI E FINITURE



BURGUNDY

Model / Modello:

*Grey and Burgundy*

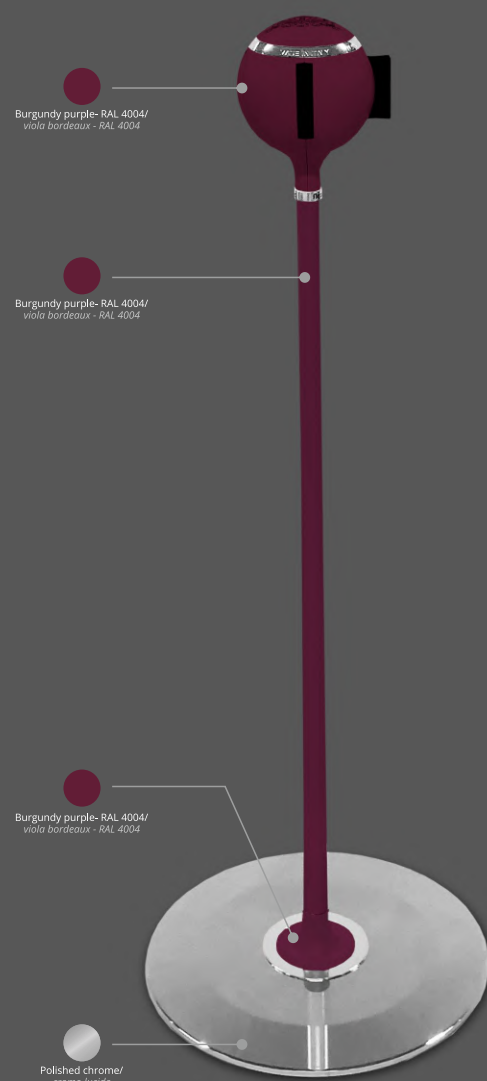

A

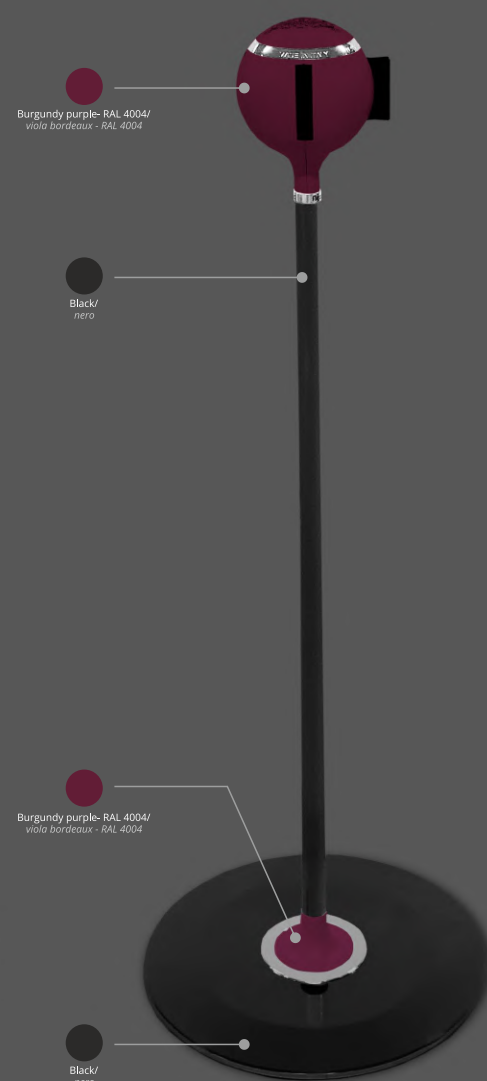

B

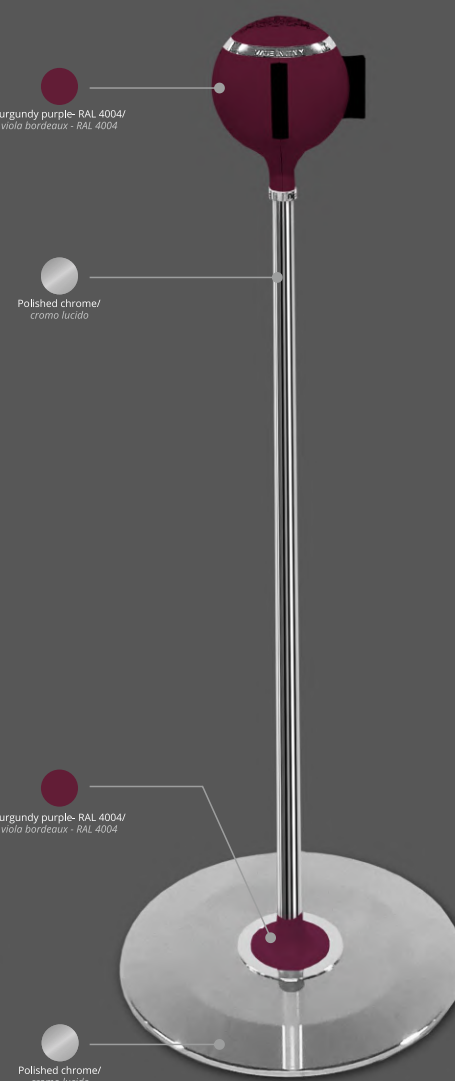

C



A

B

C





## TENDIFLEX® SPHERE - FINISHES and COLORS/ TENDIFLEX® SPHERE - COLORI E FINITURE



Model / Modello:

*Purple and Brown*



A

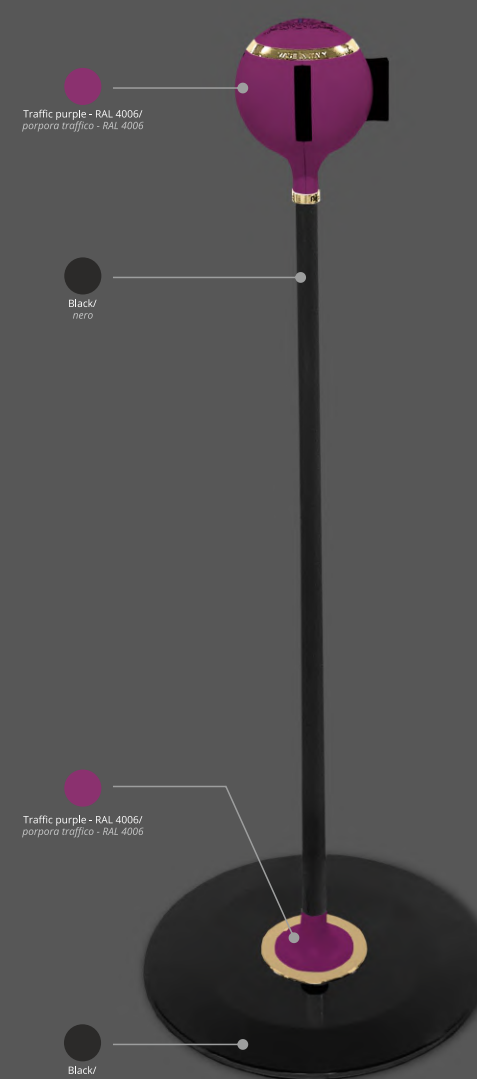

B

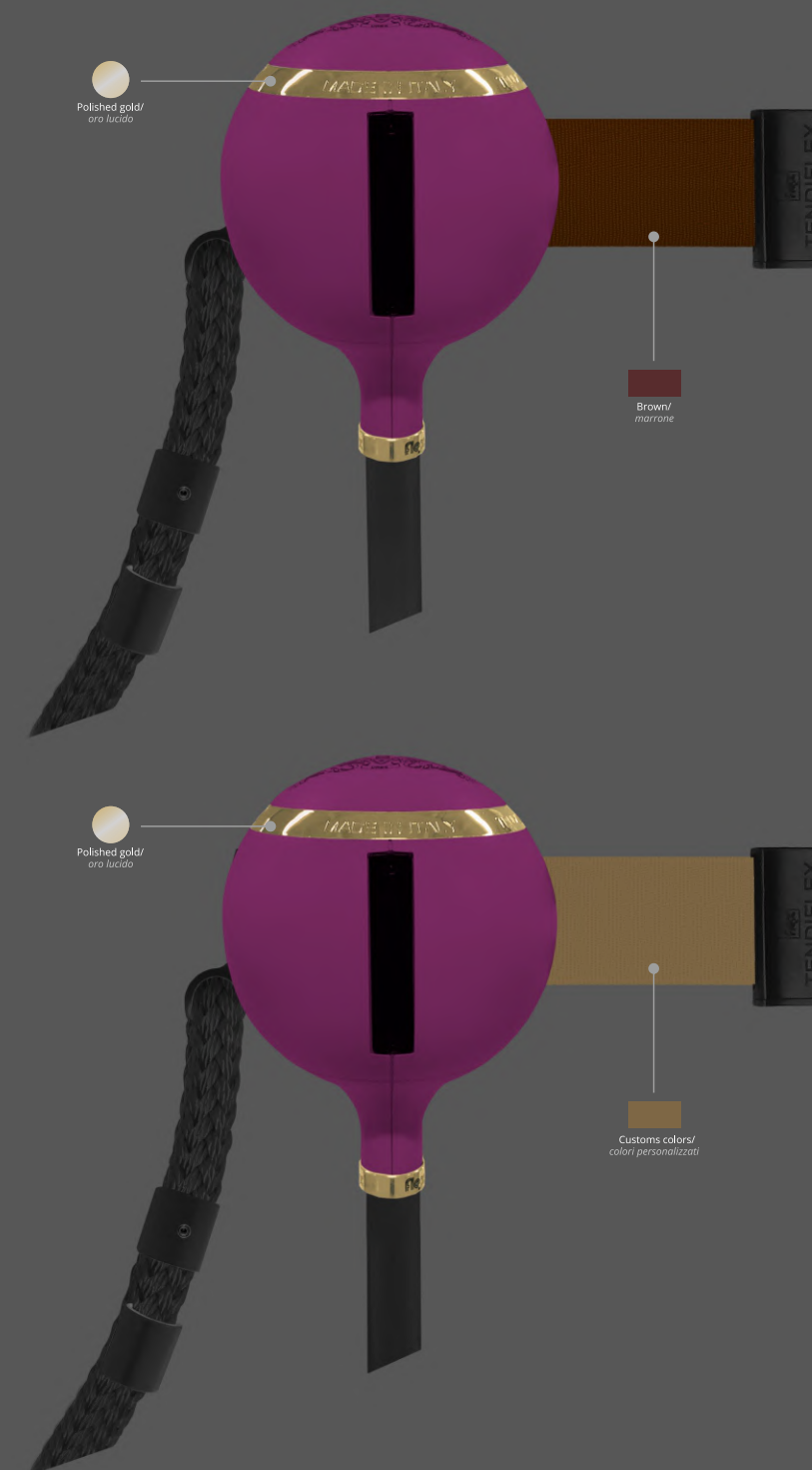

A

B



## TENDIFLEX® SPHERE - FINISHES and COLORS/ TENDIFLEX® SPHERE - COLORI E FINITURE

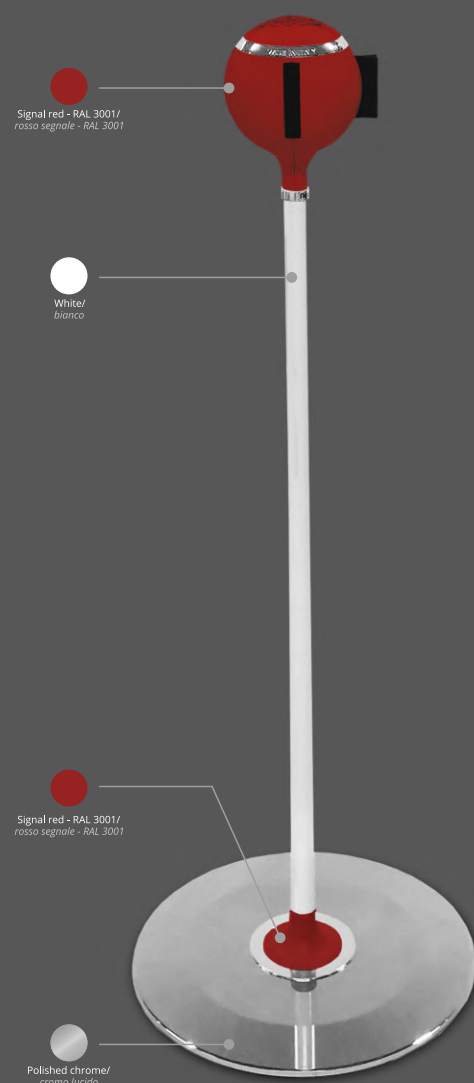

A

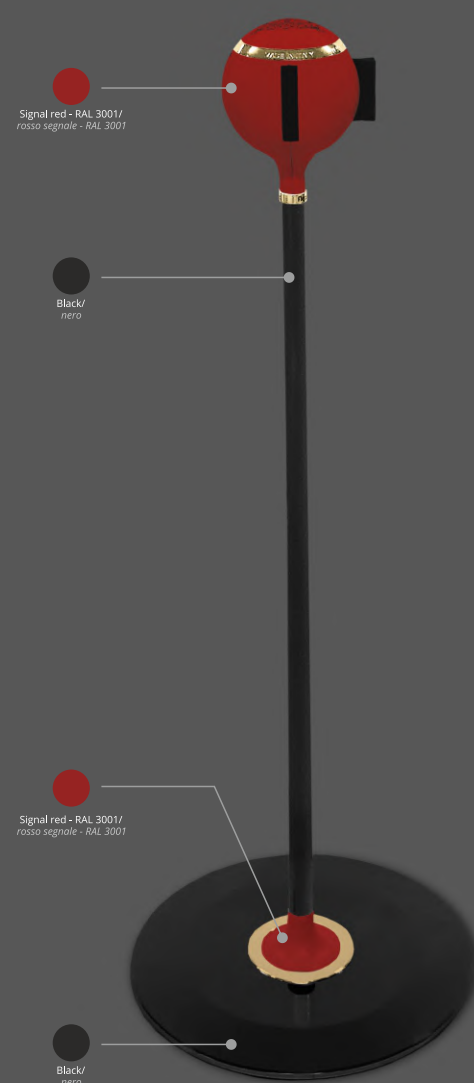

B



C

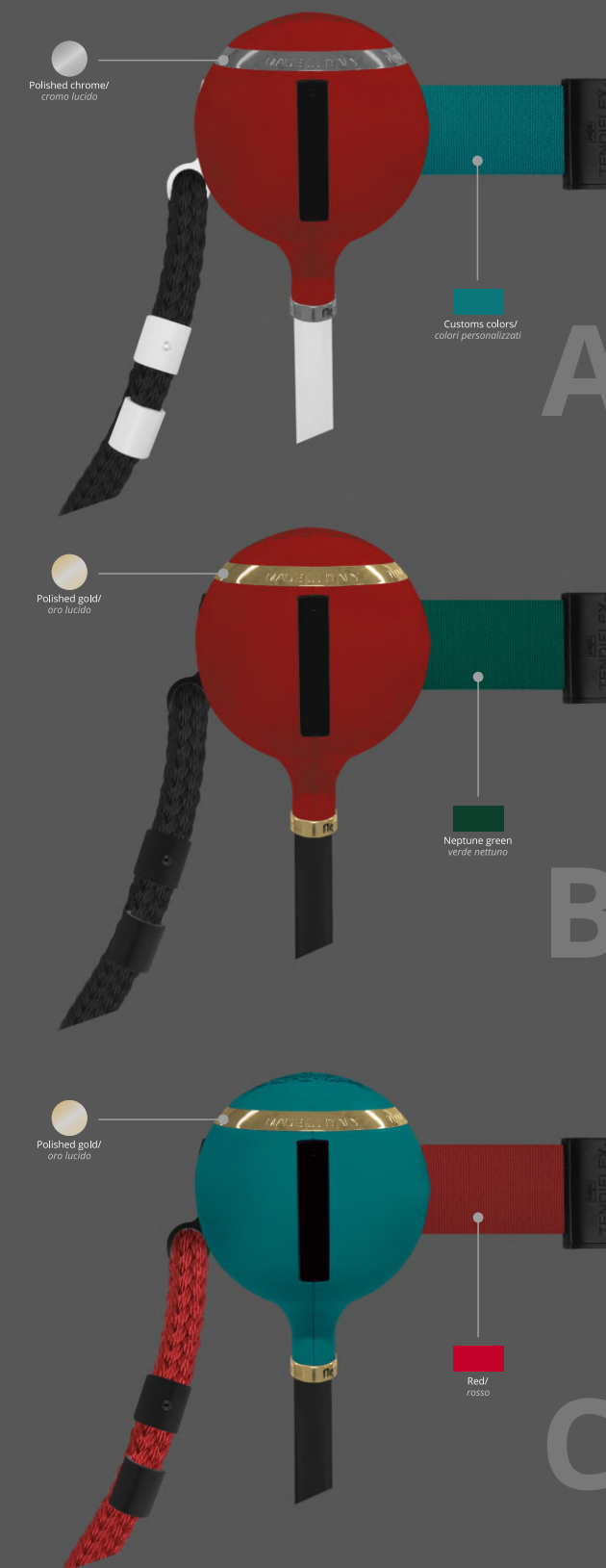

A

B

C





## TENDIFLEX® SPHERE - FINISHES and COLORS/ TENDIFLEX® SPHERE - COLORI E FINITURE

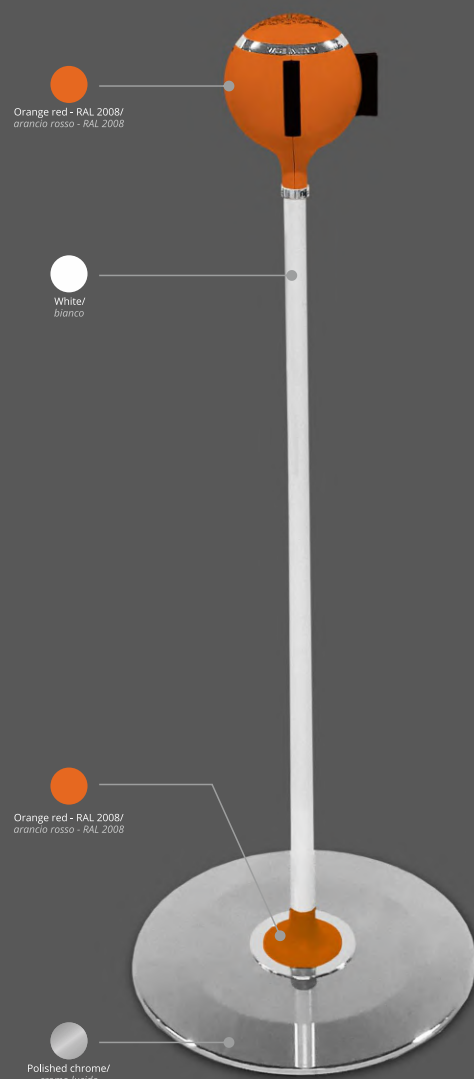

A



B

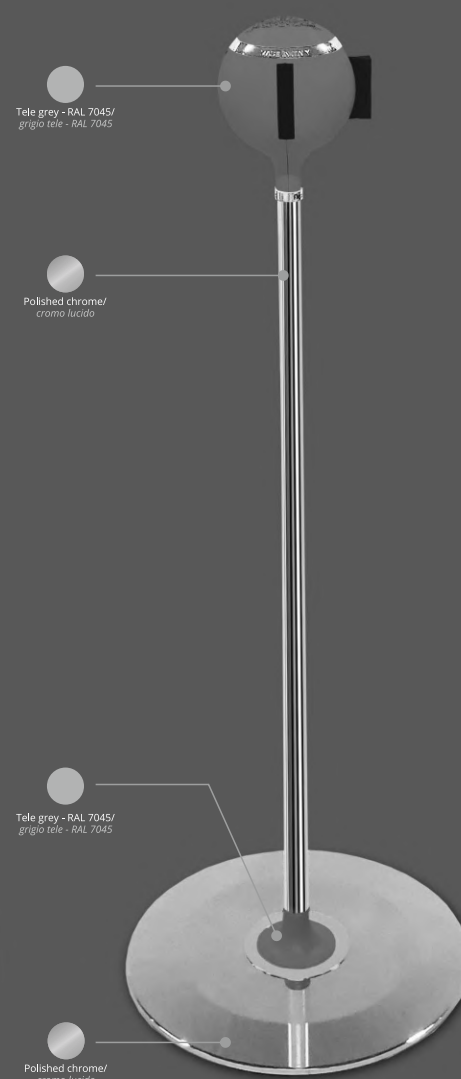

C

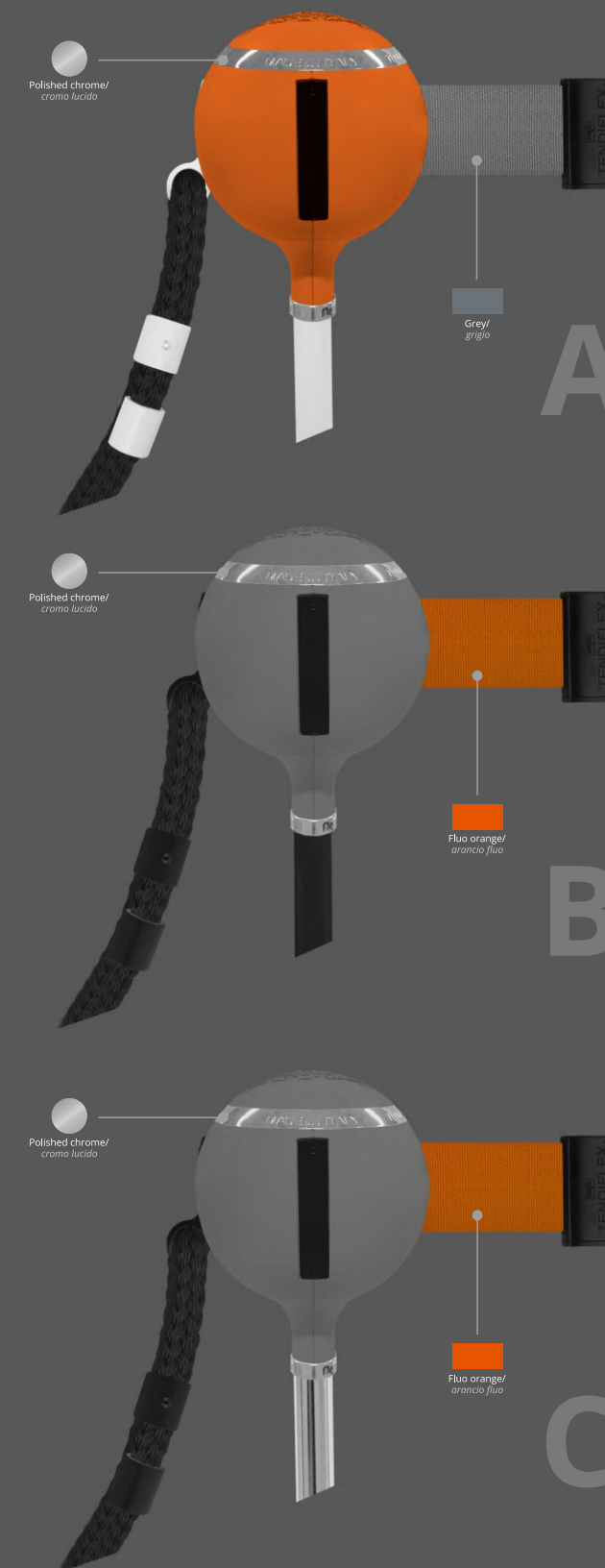

A

B

C





## TENDIFLEX® SPHERE - FINISHES and COLORS/ TENDIFLEX® SPHERE - COLORI E FINITURE

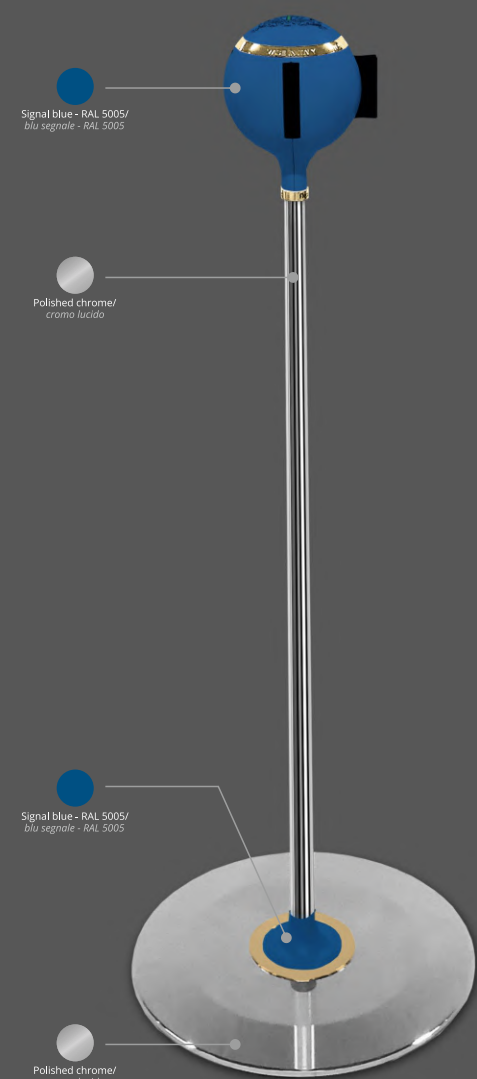

A

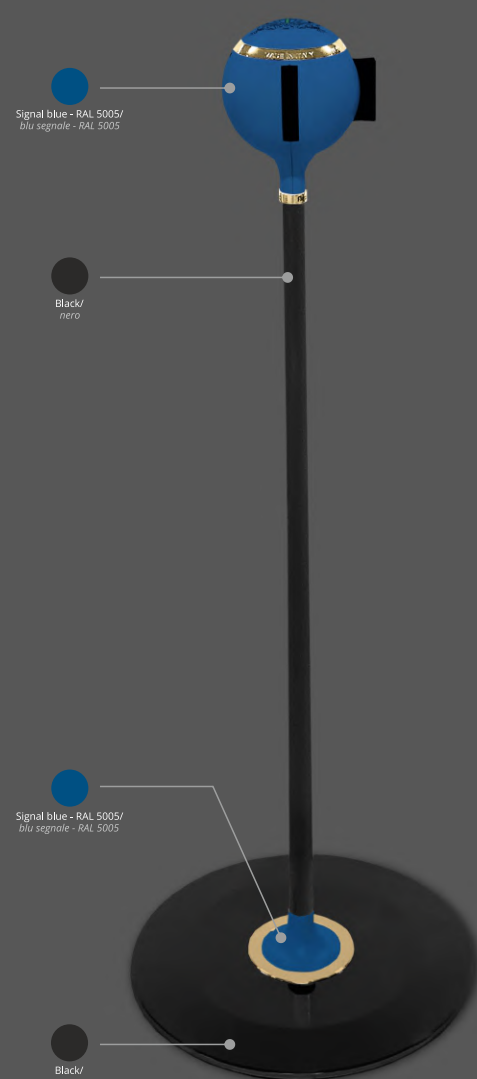

B

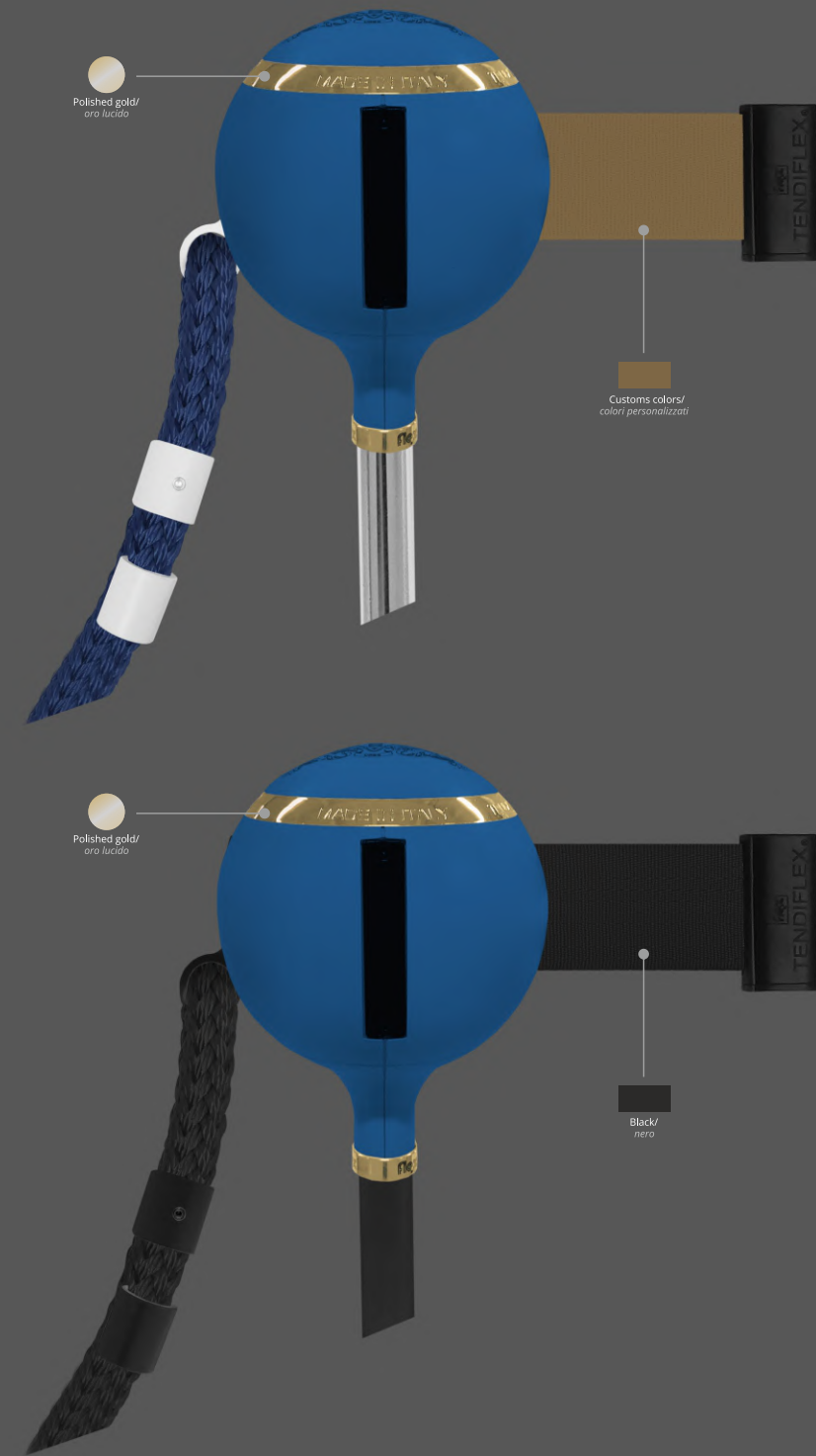

A

B



## TENDIFLEX® SPHERE - FINISHES and COLORS/ TENDIFLEX® SPHERE - COLORI E FINITURE



Model / Modello:

*Red, Black and Grey*

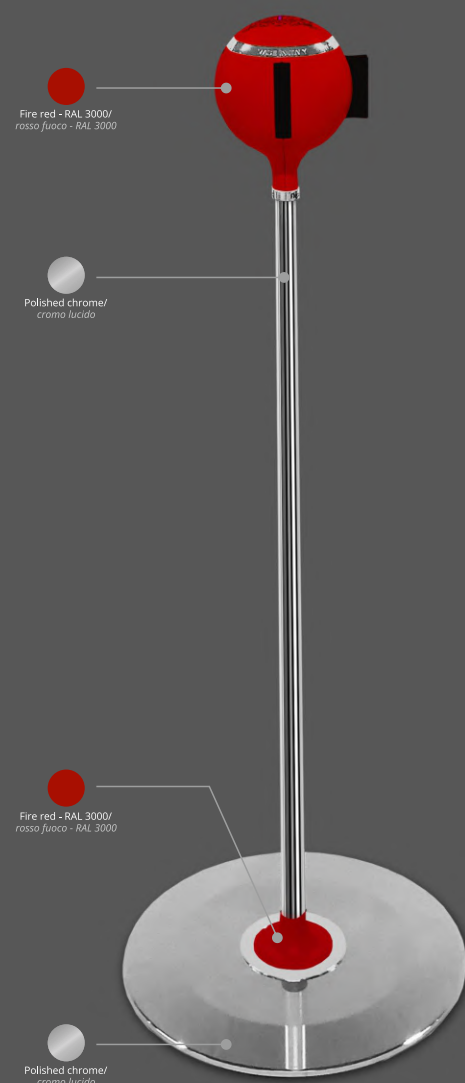

A

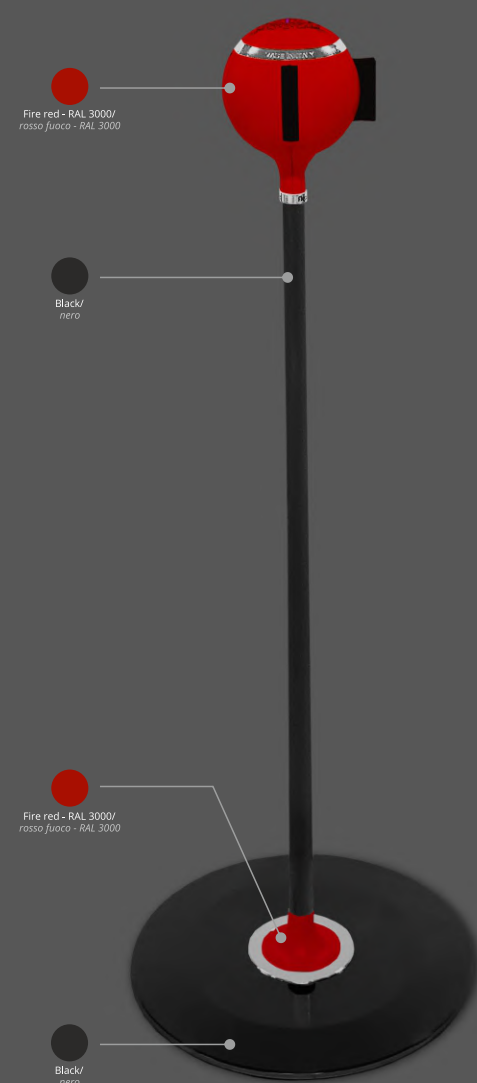

B

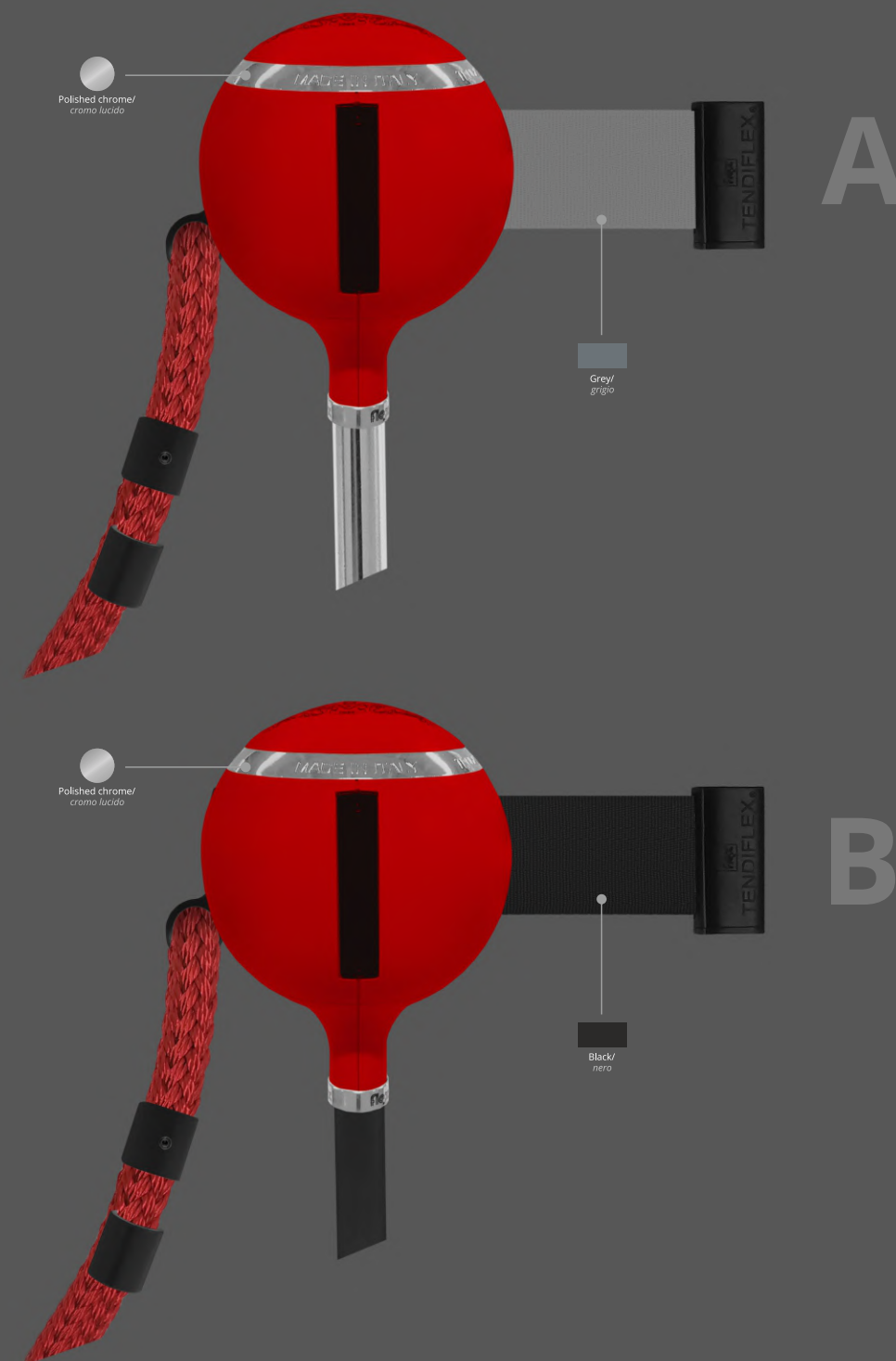

A

B









## TENDIFLEX® SPHERE - FINISHES and COLORS/ TENDIFLEX® SPHERE - COLORI E FINITURE

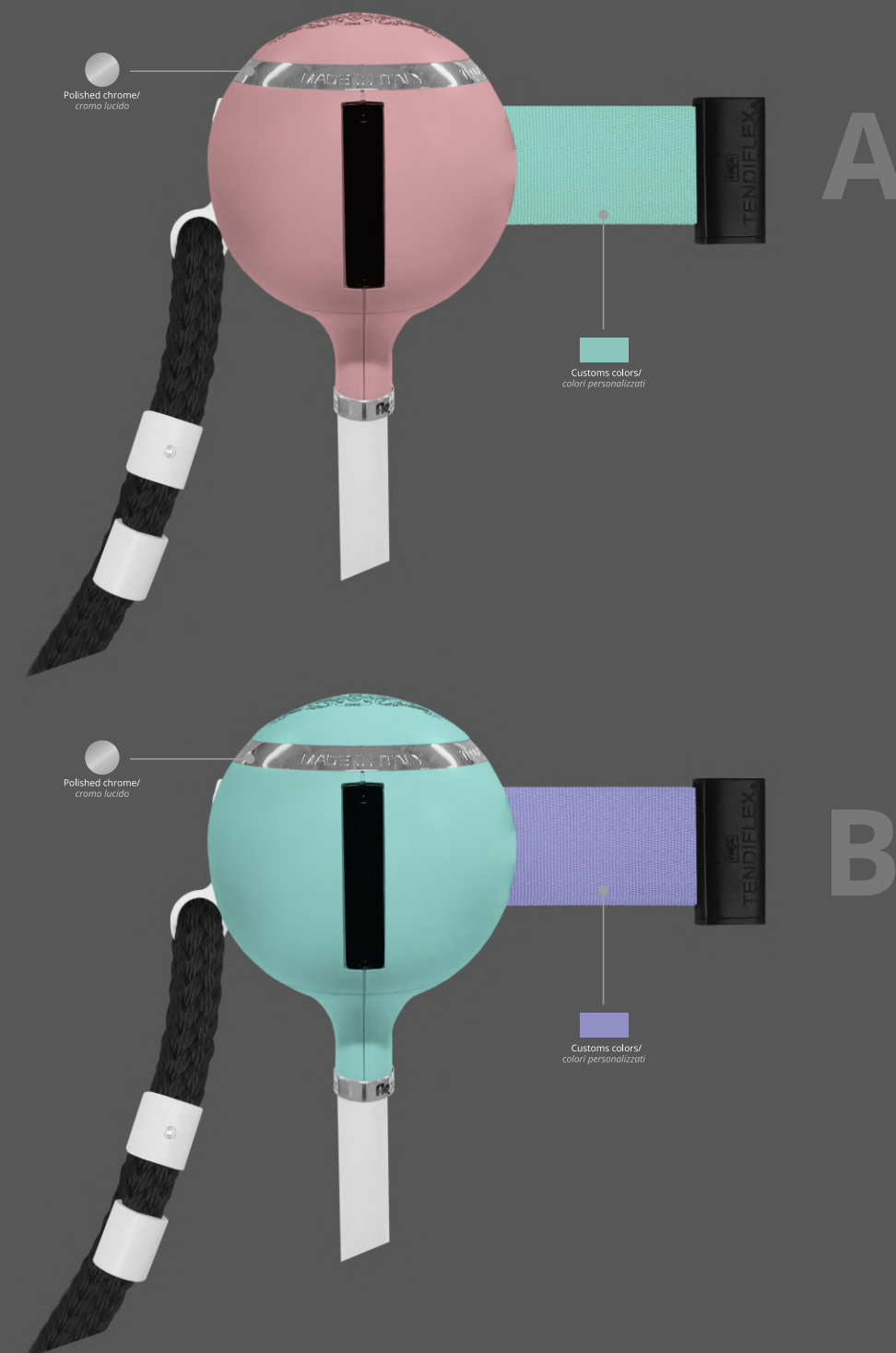
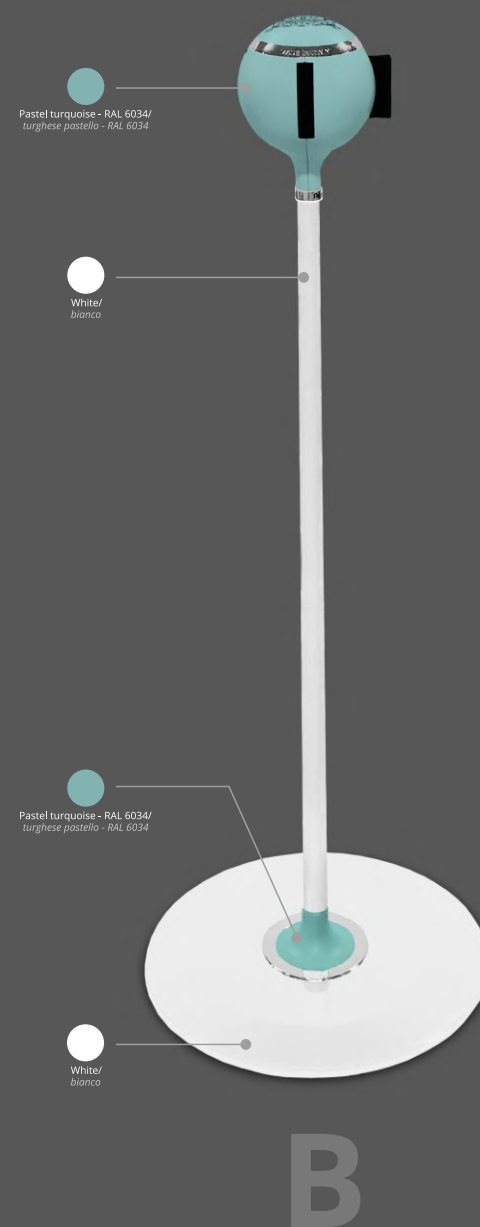
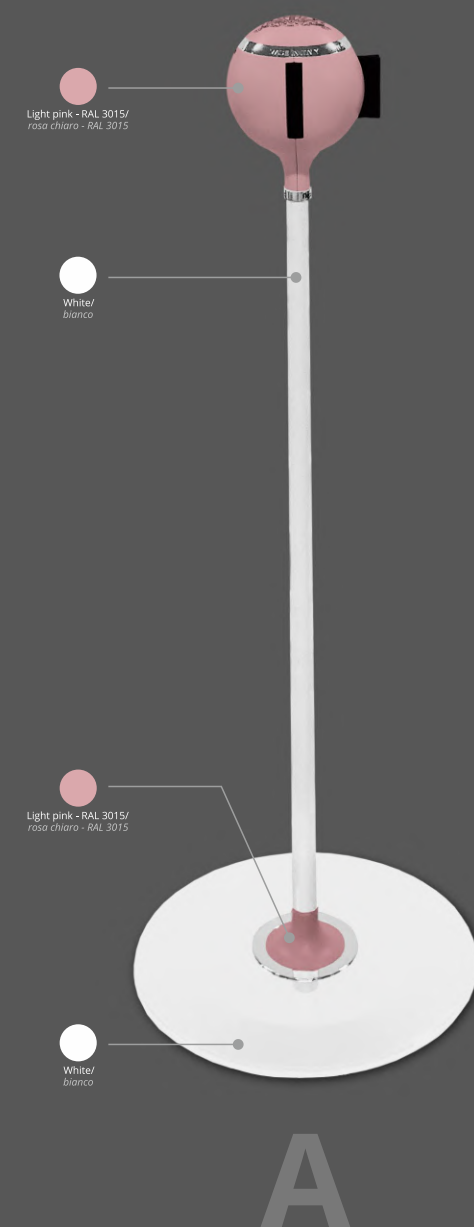



## EXAMPLES OF TOTAL CUSTOMIZATION - PLANETARIUM, SPACE and ANIMAL TEXTURES/ ESEMPI DI TOTALE PERSONALIZZAZIONE - PLANETARIO, SPAZIO e TEXTURE ANIMALI

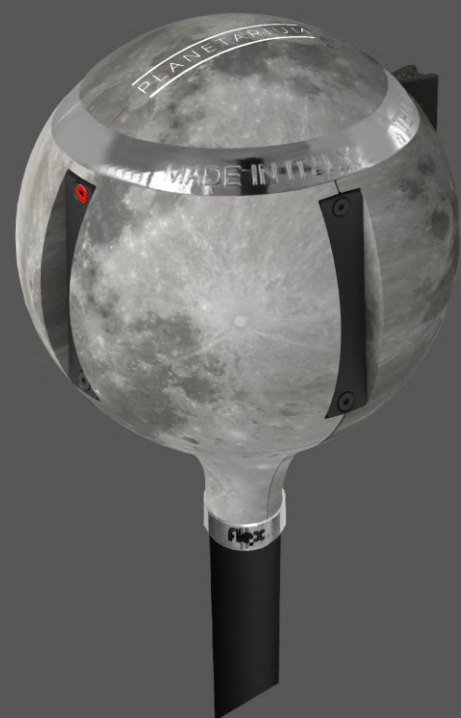

Moon / Luna



Mars / Marte



Zebra / Zebra



Cheetah / Ghepardo



Crocodile / Coccodrillo

All logos and brands represented in this catalogue are used by way of example only and shall not be considered exploited for commercial and advertising purposes. We apologize for any misinterpretation and inconvenience that may occur.

*I loghi e i marchi rappresentati in questo catalogo vengono utilizzati solo a titolo esemplificativo e non devono intendersi sfruttati per fini commerciali e pubblicitari. Ci scusiamo per qualsiasi errore di interpretazione ed inconveniente che possa verificarsi.*





## EXAMPLES OF TOTAL CUSTOMIZATION - MATERIAL TEXTURES and ARMED FORCES/ ESEMPI DI TOTALE PERSONALIZZAZIONE - TEXTURE MATERIALI e FORZE ARMATE



Black marble / *Marmo nero*

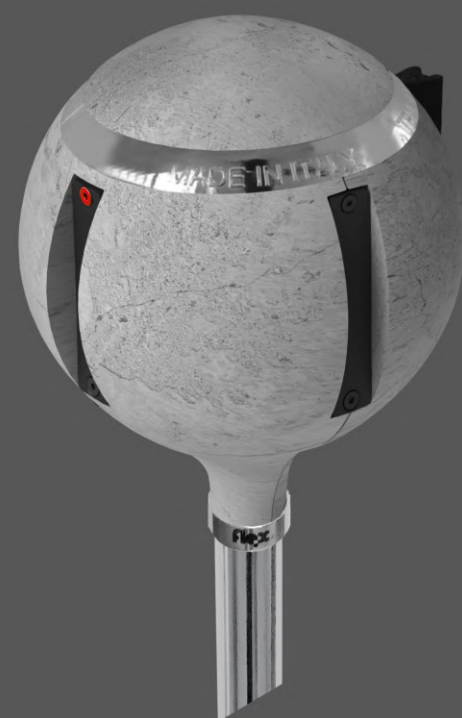

Concrete / *Cemento*



All logos and brands represented in this catalogue are used by way of example only and shall not be considered exploited for commercial and advertising purposes. We apologize for any misinterpretation and inconvenience that may occur.

*I loghi e i marchi rappresentati in questo catalogo vengono utilizzati solo a titolo esemplificativo e non devono intendersi sfruttati per fini commerciali e pubblicitari. Ci scusiamo per qualsiasi errore di interpretazione ed inconveniente che possa verificarsi.*





## EXAMPLES OF TOTAL CUSTOMIZATION - CHUPA CHUPS and PATTERNS / ESEMPI DI TOTALE PERSONALIZZAZIONE - CHUPA CHUPS e PATTERNS



Apple / Mela



Strawberry / Fragola



Orange / Arancia

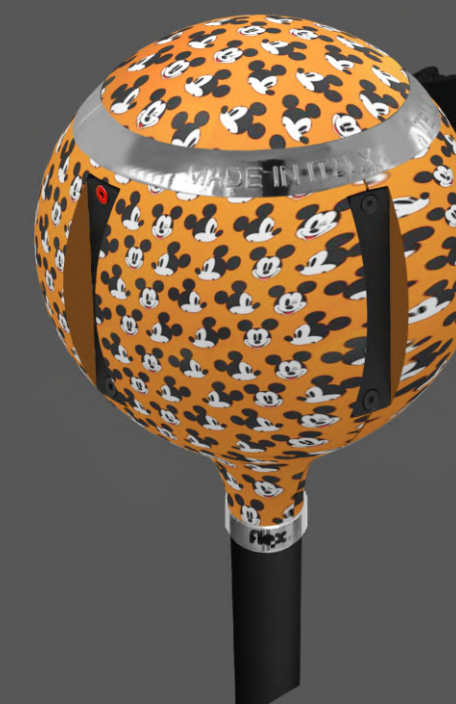

All logos and brands represented in this catalogue are used by way of example only and shall not be considered exploited for commercial and advertising purposes. We apologize for any misinterpretation and inconvenience that may occur.

*I loghi e i marchi rappresentati in questo catalogo vengono utilizzati solo a titolo esemplificativo e non devono intendersi sfruttati per fini commerciali e pubblicitari. Ci scusiamo per qualsiasi errore di interpretazione ed inconveniente che possa verificarsi.*



## Examples of use / *Esempi di utilizzo*





## Examples of use / Esempi di utilizzo





Examples of use / *Esempi di utilizzo*





Examples of use / *Esempi di utilizzo*





## Examples of use / Esempi di utilizzo





## Examples of use / Esempi di utilizzo





## Examples of use / *Esempi di utilizzo*





Examples of use / *Esempi di utilizzo*





Examples of use / *Esempi di utilizzo*





Examples of use / *Esempi di utilizzo*





## Examples of use / *Esempi di utilizzo*





## Examples of use / *Esempi di utilizzo*





Examples of use / *Esempi di utilizzo*





## Examples of use / Esempi di utilizzo





Examples of use / *Esempi di utilizzo*





## Examples of use / Esempi di utilizzo

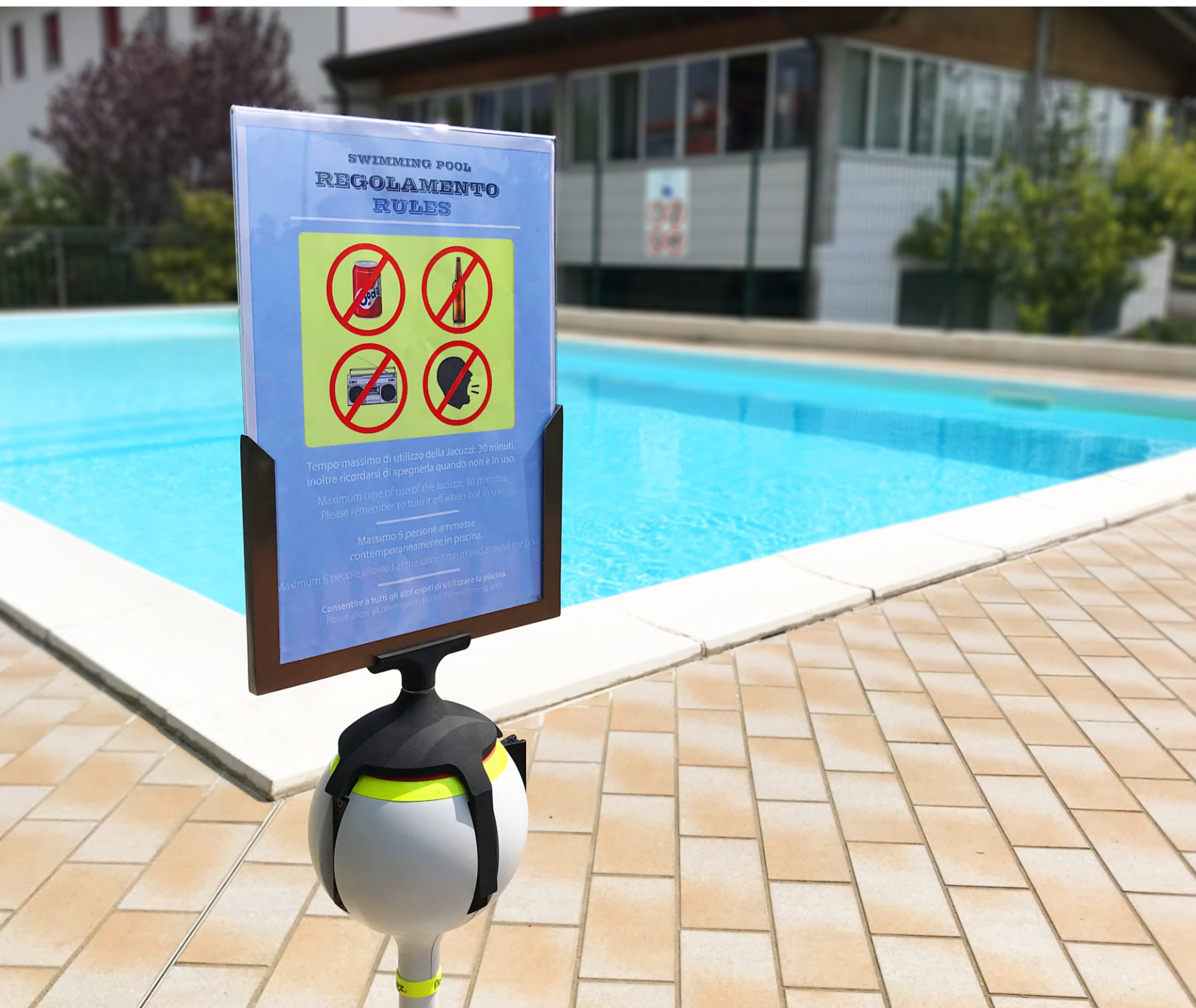



Since 1990 we have been changing the way people experience public spaces: faster pedestrian flows, clear information, impactful communication.

We bring light, color and beauty to all environments, making them better organized and more pleasant.

**Get in touch with us to find out more!**

*Dal 1990 cambiamo il modo in cui le persone vivono i luoghi pubblici: flussi pedonali più veloci, informazioni chiare, comunicazione d'impatto.*

*Portiamo luce, colore e bellezza in tutti gli ambienti, rendendoli meglio organizzati e più piacevoli.*

**Contattaci per saperne di più!**







**Flex s.r.l**

via Gaetano Bargnani, 11

25135 Brescia (BS), Italy

info@flex.it

tendiflex.it

flex.it

