



CATALOGO / CATALOGUE

MEDIA SOLUTIONS

MEDIA CHROME - MEDIA TOTEM - INTERACTIVE KIOSK



INTRODUZIONE / INTRODUCTION	3	RIEPILOGO VERSIONI - ORIZZONTALE VERSIONS SUMMARY - HORIZONTAL (LANDSCAPE)	21
MEDIA CHROME	4		
APPLICAZIONI / APPLICATIONS	6	SPECIFICHE TECNICHE / TECHNICAL SPECS	22
FORMATI DISPONIBILI - VERTICALE AVAILABLE SIZES - VERTICAL (PORTRAIT)	12	SPECIFICHE TECNICHE - ALTA LUMINOSITÀ TECHNICAL SPECS - HIGH BRIGHTNESS	23
FORMATI DISPONIBILI ALTA LUMINOSITÀ - VERTICALE HIGH BRIGHTNESS AVAILABLE SIZES - VERTICAL (PORTRAIT)	13	FUNZIONALITÀ E COMPARAZIONE TRA SOFTWARE SOFTWARE FEATURES AND COMPARISON	24
FORMATI DISPONIBILI - ORIZZONTALE AVAILABLE SIZES - HORIZONTAL (LANDSCAPE)	14	SPECIFICHE TECNICHE - OPTIONAL DISPONIBILI TECHNICAL SPECS - AVAILABLE OPTIONALS	25
FORMATI DISPONIBILI ALTA LUMINOSITÀ - ORIZZONTALE HIGH BRIGHTNESS AVAILABLE SIZES - HORIZONTAL (LANDSCAPE)	15	COMPARAZIONE TRA SISTEMI COMPARISON BETWEEN THE SYSTEMS	26
SUPPORTI DISPONIBILI AVAILABLE SUPPORTS	16	CARATTERISTICHE DISTINTIVE / DISTINCTIVE FEATURES	27
VERSIONE A - MONOFACCIALE VERSION A - SINGLE-SIDED	18	MEDIA TOTEM	28
VERSIONE B - BIFACCIALE MISTO VERSION B - DOUBLE-SIDED MIXED	19	APPLICAZIONI / APPLICATIONS	30
RIEPILOGO VERSIONI - VERTICALE VERSIONS SUMMARY - VERTICAL (PORTRAIT)	20	FORMATI DISPONIBILI - FINITURA BIANCO LUCIDO AVAILABLE SIZES - WHITE GLOSSY FINISH	36
		FORMATI DISPONIBILI - FINITURA NERO LUCIDO AVAILABLE SIZES - BLACK GLOSSY FINISH	37



FORMATI DISPONIBILI - FINITURA ACCIAIO INOX AVAILABLE SIZES - STAINLESS STEEL FINISH	38	FORMATI DISPONIBILI FINITURA ACCIAIO INOX / RIEPILOGO VERSIONI AVAILABLE SIZES STAINLESS STEEL FINISH / VERSIONS SUMMARY	52
VERSIONE A - MONOFACCIALE / VERSION A - SINGLE-SIDED	39	VERSIONE MONOFACCIALE SINGLE-SIDED VERSION	53
VERSIONE B - BIFACCIALE MISTO VERSION B - DOUBLE-SIDED MIXED	40	SPECIFICHE TECNICHE / TECHNICAL SPECS	54
VERSIONE C - BIFACCIALE MEDIA VERSION C - DOUBLE-SIDED MEDIA	41	SPECIFICHE TECNICHE - OPTIONAL DISPONIBILI TECHNICAL SPECS - AVAILABLE OPTIONALS	55
RIEPILOGO VERSIONI - VERTICALE VERSIONS SUMMARY - VERTICAL (PORTRAIT)	42	SOFTWARE APPLICATIVI - ESEMPI DI INTERFACCIA UTENTE APPLICATION SOFTWARE - USER INTERFACE EXAMPLES	56
SPECIFICHE TECNICHE / TECHNICAL SPECS	43	SOFTWARE APPLICATIVI - POTENZIALITÀ APPLICATION SOFTWARE - POTENTIAL	58
FUNZIONALITÀ E COMPARAZIONE SOFTWARE SOFTWARE FEATURES AND COMPARISON	44		
OPTIONAL DISPONIBILI / AVAILABLE OPTIONALS	45		
COMPARAZIONE TRA SISTEMI COMPARISON BETWEEN THE SYSTEMS	46		
CARATTERISTICHE DISTINTIVE / DISTINCTIVE FEATURES	47		
INTERACTIVE KIOSK	48		
APPLICAZIONI / APPLICATIONS	50		

IT | LA SOLUZIONE PER LA SEGNALETICA E LA COMUNICAZIONE DIGITALE

Scegliere le **MEDIA SOLUTIONS by FLEX** significa avere a disposizione i **display multimediali ultrasottili e ad elevata luminosità** della serie **MEDIA CHROME** e le **strutture autoportanti MEDIA TOTEM**, tramite i quali comunicare in tempo reale contenuti interattivi e dinamici attraverso **immagini, audio e video in Full HD**.

Sono inoltre disponibili su richiesta **software di segnaletica direzionale digitale**, per ampliare ulteriormente le possibilità d'uso della gamma multimediale. Il design Made in Italy, i dettagli strutturali, i numerosi optional a disposizione e la particolarità delle versioni offerte, che includono l'aggiunta di **un pannello con cambio messaggio immediato sul retro della struttura e la possibilità di avere un totem bifacciale**, completano l'unicità delle soluzioni offerte.

EN | DIGITAL SIGNAGE AND COMMUNICATION SOLUTIONS

Choosing **MEDIA SOLUTIONS by FLEX** means using the **ultra-thin, high-brightness multi-media displays** in the **MEDIA CHROME** series and the **MEDIA TOTEM freestanding displays** to communicate contents in real time, interactively and dynamically, by transferring **pictures, videos and sound** in **Full HD** format.

Digital directional signage software packages are also available on request to further extend the possible applications of the multimedia range. The Made in Italy design, the structural details, the many options available and the particular versions offered, including the addition of **a message change panel on the back of the display and the possibility of installing a double-sided totem**, all make FLEX solutions absolutely unique.





MEDIA CHROME

37"
STRECTH

42"

49"

55"

65"

IT | Le soluzioni **MEDIA CHROME** permettono la **comunicazione di contenuti quali immagini e filmati in alta risoluzione con audio**, gestiti da un semplice **palinsesto aggiornabile localmente o da remoto**.

I MEDIA CHROME sono stati studiati per rendere la **comunicazione dinamica** particolarmente elegante e leggera in ogni ambiente, grazie alla **sospensione su tenditori**, allo **spessore ridotto** dello schermo e al raffinato design della **cornice cromata**, perfettamente coordinabile ai pannelli luminosi della famiglia **LED CHROME**.

I MEDIA CHROME sono caratterizzati da una alimentazione a **bassa tensione**, ulteriore garanzia di sicurezza d'uso, da una **elevata luminosità** e dall'esclusivo **sistema di cambio messaggio immediato posteriore**, per consentirne un utilizzo bifacciale misto con una comunicazione dinamica sul fronte e una statica, ma intercambiabile, sul retro.

Infine, grazie alla **connessione HDMI**, è possibile sfruttare lo schermo in Full HD per presentazioni versatili in tempo reale, semplicemente collegandolo ai propri dispositivi quali smartphone, tablet o PC (HDMI IN Autoswitching).

EN | **MEDIA CHROME** solutions allow the **communication of contents such as images and movies in high resolution with audio**, handled by a simple **programme schedule that can be updated either locally or remotely**.

MEDIA CHROME solutions are designed to make **communication dynamic** and particularly elegant and discreet in every environment, thanks to the **suspension on tensioners**, the **reduced thickness** of the screen and the refined design of the **chromed frame**, which perfectly matches **LED CHROME** panels family.

MEDIA CHROME panels are characterised by **low voltage power supply**, a further guarantee of safety in use, **high brightness** and the exclusive **quick message change system at the back**, which allows a mixed use on both sides, with dynamic communication on the front and static interchangeable communication on the back.

Thanks to **HDMI IN autoswitching connection**, you can use the Full HD screen to present versatile contents in real time, by simply connecting it to your smartphones, other devices or PCs (HDMI IN Autoswitching).





MEDIA CHROME 55" BIFACCIALE MISTO ORIZZONTALE / MEDIA CHROME 55" DOUBLE-SIDED MIXED LANDSCAPE



MEDIA CHROME 42" MONOFACCIALE ORIZZONTALE / MEDIA CHROME 42" SINGLE-SIDED LANDSCAPE



MEDIA CHROME 49" MONOFACCIALE VERTICALE / MEDIA CHROME 49" SINGLE-SIDED PORTRAIT

MEDIA CHROME 49" MONOFACCIALE ORIZZONTALE / MEDIA CHROME 49" SINGLE-SIDED LANDSCAPE



MEDIA CHROME 55" MONOFACCIALE VERTICALE / MEDIA CHROME 55" SINGLE-SIDED PORTRAIT

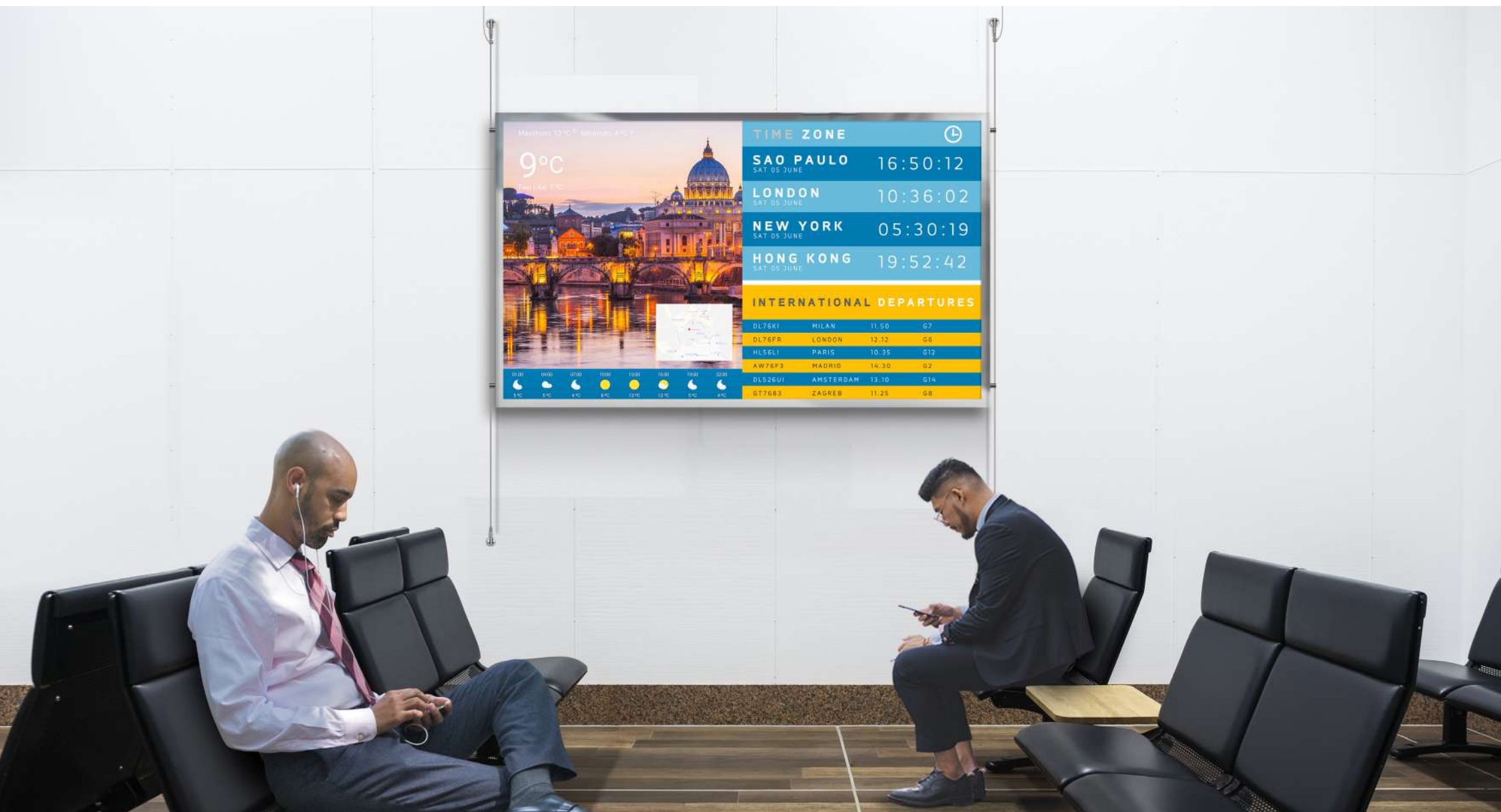

MEDIA CHROME 65" MONOFACCIALE ORIZZONTALE / MEDIA CHROME 55" SINGLE-SIDED LANDSCAPE



MEDIA CHROME 55" BIFACCIALE MISTO VERTICALE MONTATO SU DISPLAY UNIT / MEDIA CHROME 55" DOUBLE-SIDED MIXED LANDSCAPE MOUNTED ON DISPLAY UNIT



FORMATI DISPONIBILI - VERTICALE AVAILABLE SIZES - VERTICAL (PORTRAIT)

/ MEDIA SOLUTIONS

CONSIGLIATI PER USO INTERNO, ANCHE SU VETRINE CON ESPOSIZIONE **NON** DIRETTA AL SOLE - LUMINOSITÀ 700 NIT /
RECOMMENDED FOR INTERNAL USE, EVEN ON SHOP WINDOWS WITH EXPOSURE **NOT** DIRECT TO THE SUN - BRIGHTNESS 700 NIT



42"



49"



55"



65"



FORMATI DISPONIBILI ALTA LUMINOSITÀ - VERTICALE HIGH BRIGHTNESS AVAILABLE SIZES - VERTICAL (PORTRAIT)

/ MEDIA SOLUTIONS

CONSIGLIATI PER USO INTERNO SU VETRINA CON ESPOSIZIONE DIRETTA AL SOLE - LUMINOSITÀ 1500 NIT - 2500 NIT /
RECOMMENDED FOR INTERNAL USE ON SHOP WINDOWS WITH DIRECT SUN EXPOSURE - BRIGHTNESS 1500 NIT - 2500 NIT



 1500 NIT

49"



 2500 NIT

55"



FORMATI DISPONIBILI - ORIZZONTALE AVAILABLE SIZES - HORIZONTAL (LANDSCAPE)

/ MEDIA SOLUTIONS

CONSIGLIATI PER USO INTERNO, ANCHE SU VETRINE CON ESPOSIZIONE **NON** DIRETTA AL SOLE - LUMINOSITÀ 700 NIT /
RECOMMENDED FOR INTERNAL USE, EVEN ON SHOP WINDOWS WITH EXPOSURE **NOT** DIRECT TO THE SUN - BRIGHTNESS 700 NIT



37"
STRECH

42"

49"

55"

65"



FORMATI DISPONIBILI ALTA LUMINOSITÀ - ORIZZONTALE
HIGH BRIGHTNESS AVAILABLE SIZES - HORIZONTAL (LANDSCAPE)

/ MEDIA SOLUTIONS

CONSIGLIATI PER USO INTERNO SU VETRINA CON ESPOSIZIONE DIRETTA AL SOLE - LUMINOSITÀ 1500 NIT - 2500 NIT /
RECOMMENDED FOR INTERNAL USE ON SHOP WINDOWS WITH DIRECT SUN EXPOSURE - BRIGHTNESS 1500 NIT - 2500 NIT



 1500 NIT

 2500 NIT

49"

55"

IT | I MEDIA CHROME possono essere configurati all'interno di composizioni a parete o soffitto con tenditori verticali, supportati da morsetti.

Possono inoltre essere configurati su tenditori all'interno di strutture autoportanti come DISPLAY UNIT, sempre supportati da morsetti.

EN | MEDIA CHROME can be configured in layouts with vertical tensioners, supported by clamps.

They can also be installed on tensioners in free-standing structures such as DISPLAY UNIT, always supported by clamps.



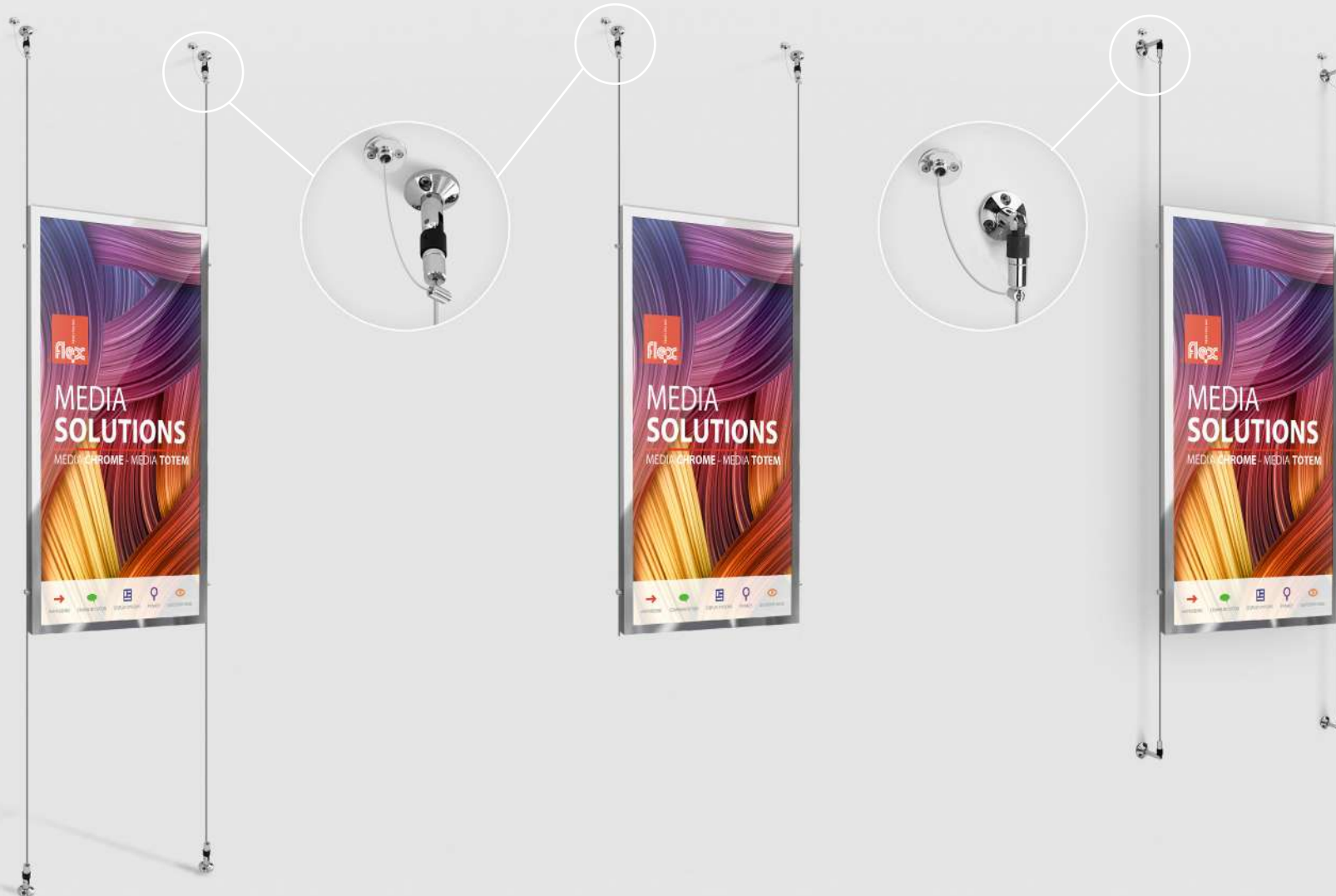

**FISSAGGIO SOFFITTO-PAVIMENTO /
CEILING-FLOOR FIXING
CAVI E STILO / CABLES AND STILO**

**FISSAGGIO SOFFITTO-SOSPESO /
CEILING-SUSPENDED FIXING
SOLO STILO / ONLY STILO**

**FISSAGGIO PARETE-PARETE /
WALL-WALL FIXING
CAVI E STILO / CABLES AND STILO**



FRONTE MONOFACCIALE /
FRONT SINGLE-SIDED



RETRO MONOFACCIALE /
BACK SINGLE-SIDED

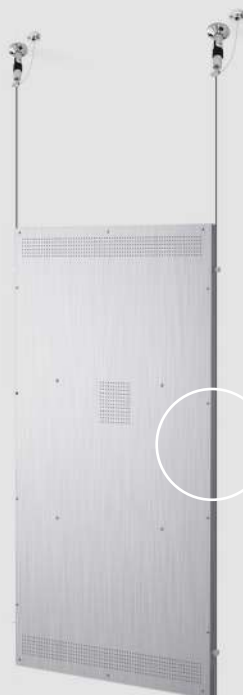

OUTPUT AUDIO
Stereo 2x5 W
audio output (L/R)

AUDIO OUTPUT
Stereo 2x5 W
audio output (L/R)

LCD DIGITAL

**FRONTE BIFACCIALE MISTO /
FRONT DOUBLE-SIDED MIXED**



LCD DIGITAL

**RETRO BIFACCIALE MISTO /
BACK DOUBLE-SIDED MIXED**



**PANNELLO CAMBIO MESSAGGIO /
MESSAGE CHANGE PANEL**



OUTPUT AUDIO
Stereo 2x5 W
audio output (L/R)

AUDIO OUTPUT
Stereo 2x5 W
audio output (L/R)



PANNELLO CAMBIO MESSAGGIO
Sollevando la cornice magnetica è possibile una rapida sostituzione del messaggio: apri, togli e sostituisci.

MESSAGE CHANGE PANEL
Just raise the magnetic frame and replace the notice: open, remove and insert.

42"

MONOFACCIALE / SINGLE-SIDED

FRONTE / FRONT: LCD DIGITAL 42"

BIFACCIALE MISTO / DOUBLE-SIDED MIXED

FRONTE / FRONT: LCD DIGITAL 42"

RETRO / BACK: PANNELLO CAMBIO MESSAGGIO 50x70 cm / MESSAGE CHANGE PANEL 50x70 cm

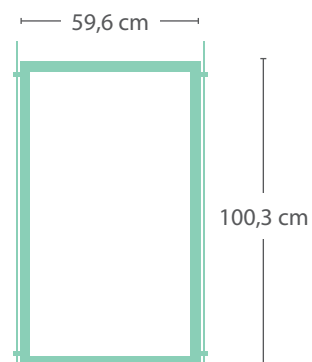

AREA ATTIVA / ACTIVE AREA

52,4x93,1 cm

49"

MONOFACCIALE / SINGLE-SIDED

FRONTE / FRONT: LCD DIGITAL 49"

BIFACCIALE MISTO / DOUBLE-SIDED MIXED

FRONTE / FRONT: LCD DIGITAL 49"

RETRO / BACK: PANNELLO CAMBIO MESSAGGIO 50x70 cm / MESSAGE CHANGE PANEL 50x70 cm

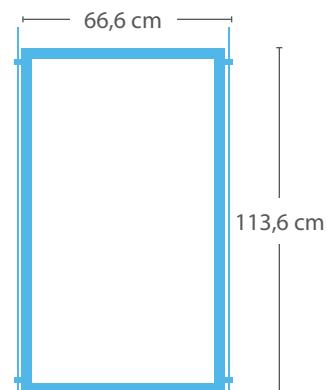

AREA ATTIVA / ACTIVE AREA

60,4x107,4 cm

55"

MONOFACCIALE / SINGLE-SIDED

FRONTE / FRONT: LCD DIGITAL 55"

BIFACCIALE MISTO / DOUBLE-SIDED MIXED

FRONTE / FRONT: LCD DIGITAL 55"

RETRO / BACK: PANNELLO CAMBIO MESSAGGIO 70x100 cm / MESSAGE CHANGE PANEL 70x100 cm

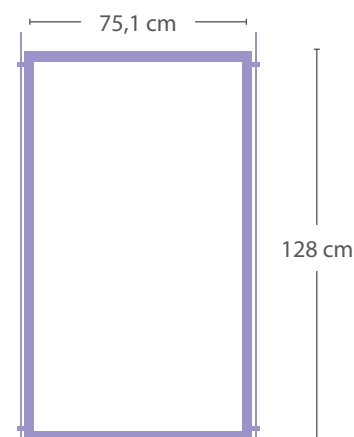

AREA ATTIVA / ACTIVE AREA

68,1x121 cm

65"

MONOFACCIALE / SINGLE-SIDED

FRONTE / FRONT: LCD DIGITAL 65"

BIFACCIALE MISTO / DOUBLE-SIDED MIXED

FRONTE / FRONT: LCD DIGITAL 65"

RETRO / BACK: PANNELLO CAMBIO MESSAGGIO 70x100 cm / MESSAGE CHANGE PANEL 70x100 cm

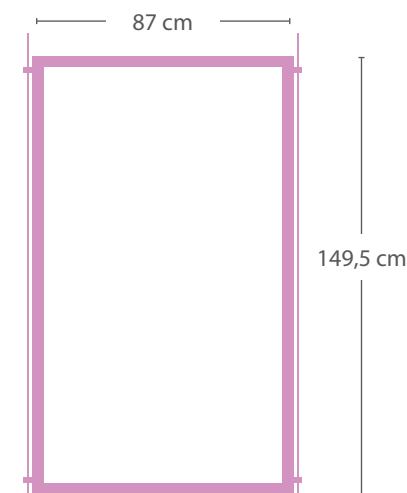

AREA ATTIVA / ACTIVE AREA

80,3x142,8 cm



37"
STRECH

42"

49"

55"

65"

MONOFACCIALE / SINGLE-SIDED

FRONTE / FRONT: LCD DIGITAL 37

MONOFACCIALE / SINGLE-SIDED

FRONTE / FRONT: LCD DIGITAL 42

MONOFACCIALE / SINGLE-SIDED

FRONTE / FRONT: LCD DIGITAL 49

MONOFACCIALE / SINGLE-SIDED

FRONTE / FRONT: LCD DIGITAL 55

MONOFACCIALE / SINGLE-SIDED

FRONTE / FRONT: LCD DIGITAL 65

BIFACCIALE MISTO / DOUBLE-SIDED MIXED

FRONTE / FRONT: LCD DIGITAL 42

RETRO / BACK: PANNELLO CAMBIO MESSAGGIO 70X50 cm / MESSAGE CHANGE PANEL

BIFACCIALE MISTO / DOUBLE-SIDED MIXED

FRONTE / FRONT: LCD DIGITAL 49

RETRO / BACK: PANNELLO CAMBIO MESSAGGIO 70X50 cm / MESSAGE CHANGE PANEL

BIFACCIALE MISTO / DOUBLE-SIDED MIXED

FRONTE / FRONT: LCD DIGITAL 55

RETRO / BACK: PANNELLO CAMBIO MESSAGGIO 100X70 cm / MESSAGE CHANGE PANEL

BIFACCIALE MISTO / DOUBLE-SIDED MIXED

FRONTE / FRONT: LCD DIGITAL 65

RETRO / BACK: PANNELLO CAMBIO MESSAGGIO 100X70 cm / MESSAGE CHANGE PANEL

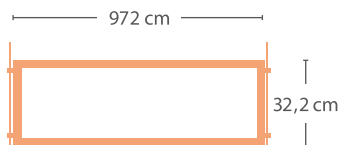

AREA ATTIVA / ACTIVE AREA
90,4x25,4 cm

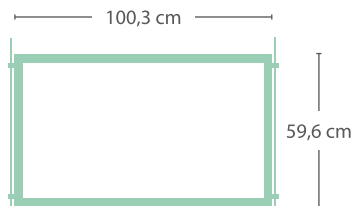

AREA ATTIVA / ACTIVE AREA
93,1x52,4 cm

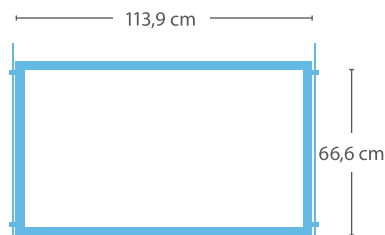

AREA ATTIVA / ACTIVE AREA
107,4x60,4 cm

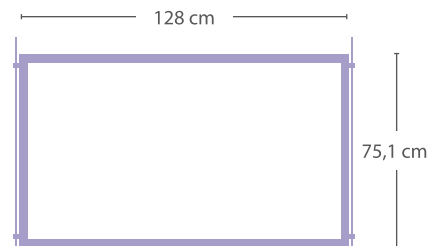

AREA ATTIVA / ACTIVE AREA
121x68,1 cm

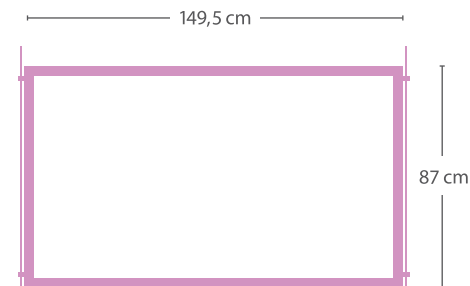

AREA ATTIVA / ACTIVE AREA
142,8x80,3 cm

CONSIGLIATI PER USO INTERNO, ANCHE SU VETRINE CON ESPOSIZIONE **NON** DIRETTA AL SOLE - LUMINOSITÀ 700 NIT /
RECOMMENDED FOR INTERNAL USE, EVEN ON SHOP WINDOWS WITH EXPOSURE **NOT** DIRECT TO THE SUN - BRIGHTNESS 700 NIT



	37" STRETCH	42"	49"	55"	65"
DIMENSIONE DISPLAY / DISPLAY SIZE	37"	42"	49"	55"	65"
AREA ATTIVA / ACTIVE AREA	90,4x25,4 cm	93,1x52,4 cm	107,4x60,4 cm	121x68,1 cm	142,8x80,3 cm
RISOLUZIONE / RESOLUTION	1920x540 px	1920x1080 px	1920x1080 px	1920x1080 px	1920x1080
PROPORZIONE / ASPECT RATIO	Wide 16:4,5	Wide 16:9	Wide 16:9	Wide 16:9	Wide 16:9
LUMINOSITÀ MASSIMA / MAX BRIGHTNESS	700 cd/m ²	700 cd/m ²	700 cd/m ²	700 cd/m ²	700 cd/m ²
RETROILLUMINAZIONE / BACKLIGHT	LEDedge	LEDedge	LEDedge	LEDedge	LEDedge
CONTRASTO / CONTRAST	4000:1 (typ)	4000:1 (typ)	1300:1 (typ)	4000:1 (typ)	4000:1 (typ)
ANGOLO DI VISIONE / VIEWING ANGLE	178°/178°	178°/178°	178°/178°	178°/178°	178°/178°
DURATA LUMINOSITÀ OTTIMALE* / OPTIMAL BRIGHTNESS DURATION*	50.000 h	50.000 h	60.000 h	60.000 h	50.000 h
LATO LUNGO / LONG SIDE (L)	97,2 cm	100,3 cm	113,6cm	128 cm	149,5 cm
LATO CORTO / SHORT SIDE (S)	32,2 cm	59,6 cm	66,6cm	75,1 cm	87,0cm
PROFONDITÀ / DEPTH (D)	4 cm	4 cm	4 cm	4 cm	5cm
POTENZA ASSORBITA / POWER COM. (TYP.)	70 W	100 W	120 W	125 W	250 W
TEMPERATURA DI ESERCIZIO / OPERATIONAL TEMPERATURE	+5°/+40° C	+5°/+40° C	+5°/+40° C	+5°/+40° C	+5°/+40° C
TEMPERATURA DI STOCCAGGIO / STORAGE TEMPERATURE	+5°/+50° C	+5°/+50° C	+5°/+50° C	+5°/+50° C	+5°/+50° C
PESO / WEIGHT	8 kg	16 kg	22 kg	27 kg	46 kg

* Periodo oltre al quale la luminosità del display scende al di sotto del 50% rispetto al suo valore originale /
* Period over which the brightness of the display falls below 50% compared to its original value.

CONSIGLIATI PER USO INTERNO SU VETRINA CON ESPOSIZIONE DIRETTA AL SOLE - LUMINOSITÀ 1500 NIT - 2500 NIT /
RECOMMENDED FOR INTERNAL USE ON SHOP WINDOWS WITH DIRECT SUN EXPOSURE - BRIGHTNESS 1500 NIT - 2500 NIT



	49"	55"
DIMENSIONE DISPLAY / DISPLAY SIZE	49"	55"
AREA ATTIVA / ACTIVE AREA	107,4x60,4 cm	121x68,1 cm
RISOLUZIONE / RESOLUTION	1920x1080 px	1920x1080 px
PROPORZIONE / ASPECT RATIO	Wide 16:9	Wide 16:9
LUMINOSITÀ MASSIMA / MAX BRIGHTNESS	1500 cd/m ²	2500 cd/m ²
RETROILLUMINAZIONE / BACKLIGHT	LEDedge	LEDedge
CONTRASTO / CONTRAST	1300:1 (typ)	4000:1 (typ)
ANGOLO DI VISIONE / VIEWING ANGLE	178°/178°	178°/178°
DURATA LUMINOSITÀ OTTIMALE* / OPTIMAL BRIGHTNESS DURATION*	60.000 h	60.000 h
LATO LUNGO / LONG SIDE (L)	113,6cm	129,5 cm
LATO CORTO / SHORT SIDE (S)	66,6cm	76,5 cm
PROFONDITÀ / DEPTH (D)	4 cm	9 cm
POTENZA ASSORBITA / POWER COM. (TYP)	120 W	360 W
TEMPERATURA DI ESERCIZIO / OPERATIONAL TEMPERATURE	+5°/+40° C	+5°/+40° C
TEMPERATURA DI STOCCAGGIO / STORAGE TEMPERATURE	+5°/+50° C	+5°/+50° C
PESO / WEIGHT	22 kg	35 kg

* Periodo oltre al quale la luminosità del display scende al di sotto del 50% rispetto al suo valore originale /
* Period over which the brightness of the display falls below 50% compared to its original value.

VERSIONE STANDARD (MXP)

La versione STANDARD MXP del MEDIA CHROME è ideale per la comunicazione di contenuti a pieno schermo, quali immagini e filmati con audio in alta risoluzione. I contenuti memorizzati internamente al MEDIA CHROME possono essere riprodotti in modo ciclico o secondo una programmazione del palinsesto, definita tramite un apposito software previsto a corredo della fornitura.

L'aggiornamento può avvenire tramite server FTP o tramite chiavetta USB.

The STANDARD MXP version of MEDIA CHROME is ideal for the communication of contents at full screen such as high resolution images and movies with audio. The contents stored into MEDIA CHROME can be played in loop or according to a schedule defined using a dedicated software provided with the panel.

The upload of contents through FTP server or USB key.



VERSIONE STANDARD (VIDEOPOSTER)

La versione STANDARD VIDEOPOSTER del MEDIA CHROME è ideale per la comunicazione di contenuti a pieno schermo, quali immagini e filmati con audio in alta risoluzione. I contenuti memorizzati internamente al MEDIA CHROME possono essere riprodotti in modo ciclico o secondo una programmazione del palinsesto, definita tramite un apposito software previsto a corredo della fornitura.

L'aggiornamento può avvenire tramite LAN o tramite chiavetta USB.

The STANDARD VIDEOPOSTER version of MEDIA CHROME is ideal for the communication of contents at full screen such as high resolution images and movies with audio. The contents stored into MEDIA CHROME can be played in loop or according to a schedule defined using the dedicated software provided with the panel.

The upload of contents through LAN server or USB key.



VERSIONE ADVANCED (NUC I5)

La versione ADVANCED del MEDIA CHROME è dotata di un PC interno Intel, con sistema operativo Windows e consente di collegare tutti i dispositivi compatibili.

NOTA: in questa versione non viene incluso alcun software di digital signage o di gestione contenuti.

TheADVANCED version of MEDIA CHROME has an internal Intel PC with Windows operating system and allows the connection of all the compatible devices.

NOTE: this release does not include any software or digital signage content management.



	STANDARD (MXP)	STANDARD (VIDEOPOSTER)	ADVANCED (NUC I5)
 SOFTWARE UPGRADE CLOUD SOLUTION*			
 SYNCHRO ADD-ON**			
 HDMI IN AUTOSWITCHING***			
 PERSONALIZZAZIONE LOGO CLIENTE / CLIENT LOGO CUSTOMIZATION			
 DISPLAY UNIT_square (dimensioni: 160x240 cm) / DISPLAY UNIT_square (dimensions: 160x240 cm)			

 OPTIONAL SOFTWARE / SOFTWARE OPTIONALS

 OPTIONAL STRUTTURALI / STRUCTURAL OPTIONALS

*Costo servizio Cloud escluso / Cost of Cloud service excluded

**Per sincronizzare due o più Media Chrome / To synchronize two or more Media Chrome

***Nella versione Standard Videoposter già incluso / In the Standard Videoposter version already included



CARATTERISTICHE / FEATURES	STANDARD MXP	STANDARD VIDEOPOSTER	ADVANCED NUC 15
Sistema Operativo - Licenze / Operation System - License	Sistema Linux Incluso / Linux Based Included free	Sistema Linux Incluso / Linux Based Included free	Windows 10
Wi-Fi	Incluso / Included	Incluso / Included	Incluso / Included
HDMI IN Autoswitching	YES (Optional)	Incluso / Included	YES (Optional)
HDMI OUT	NO	NO	YES
Gestione delle periferiche (stampanti, lettori ottici, webcam, touch, ecc.)/ Device management (printers, optical readers, webcam, touch, etc.)	NO	NO	YES
Caricamento tramite USB/ Uploading by USB	YES	YES	YES
Caricamento tramite NET/ Uploading by NET	NO	YES	YES
Caricamento tramite FTP/ Uploading by FTP	YES	NO	YES
Sincronizzazione (versioni bifacciali o più schermi) / Synchro (double-sided versions or more screens)	YES	NO	NO
Divisione schermi / Screen divisions	YES	NO	Specifico software (non incluso) / Specific software (not included)
File video	YES	YES	YES
File Immagine / File Image	YES	YES	YES
Altri Files / Other Files	NO	Pdf	Tutti i tipi con specifico software (non incluso) / All types with specific software (not included)
Configurazione/ Configuration	solo Software / Software only	Software e pagina Web / Software and Web page	politica Windows / Windows policy
Gestione/ Management	solo Software / Software only	Software e pagina Web / Software and Web page	politica Windows / Windows policy
Software	Configuratore MXP / MXP Configurator	ACC	-



Elevata luminosità con consumi contenuti ed ecosostenibili /
High brightness with low power and sustainable consumption



Lifetime elevato
(50.000 - 60.000 ore) /
High lifetime
(50.000 - 60.000 hours)



Gestione remota tramite rete e semplicità di utilizzo del software /
Remote easy to use management network and software



Compatibilità con sorgenti video esterne (tablet e PC) /
Compatibility with external video sources (other devices or PCs)



Totale assenza di ventole per evitare rumori fastidiosi /
Totally fanless to avoid annoying noises



Bassa tensione (24 V) per una maggiore sicurezza /
Low voltage power (24 V) for a better safety



Flessibilità di installazione grazie al sistema su Stilo /
Flexible installation thanks to the Stilo system



Spessore contenuto che include tutto il necessario /
Low Thickness which includes everything you need



Media player integrato /
Built in media player



MEDIA TOTEM

42"

55"

65"

IT | La soluzione proposta dalle strutture autoportanti **MEDIA TOTEM** offre il massimo della **comunicazione dinamica tradizionale ad elevata luminosità**, che può essere ulteriormente arricchita dalle funzionalità **touchscreen** o personalizzata grazie a **diversi software**, disponibili su richiesta.

Come avviene per i MEDIA CHROME, anche il **palinsesto di filmati e immagini con audio in Full HD** dei totem può essere **aggiornato localmente o da remoto**.

Il design delle strutture autoportanti permette di ottenere soluzioni multimediali di ultima generazione in uno spessore contenuto, attraverso materiali che ne valorizzano l'estetica quali **vetro, acciaio e vernici lucide**.

I totem sono disponibili nelle versioni **monofacciale, bifacciale multimediale** con comunicazione dinamica su entrambi i lati, oppure nell'esclusiva **versione mista** con un **pannello a LED dal cambio messaggio immediato** sul retro della struttura.

EN | The solution proposed by **MEDIA TOTEM** freestanding displays provides the ultimate in **high brightness, dynamic, conventional communication**, which can be further enhanced by **touchscreen** or customized functions, thanks to a **different software package** that is available on request.

As with MEDIA CHROME, the **programme schedule of totems with movies and images with sound in Full HD** format can be **updated either locally or remotely**.

The design of self-standing structures makes it possible to obtain latest-generation multimedia solutions that feature reduced thickness, thanks to the use of materials such as **glass, steel** and **glossy paints**, giving enhanced aesthetic appearance.

The totems are available in the **single-sided** version, **multi-media double-sided** version with dynamic communication on both sides, or in the exclusive **mixed version** with a **LED panel featuring quick message change** on the back of the structure.





CREDITI IMMAGINE / IMAGE CREDITS: Flickr - Land Rover MENA (CC Attribution 2.0)

MEDIA TOTEM 55" MONOFACCIALE / MEDIA TOTEM 55" SINGLE-SIDED

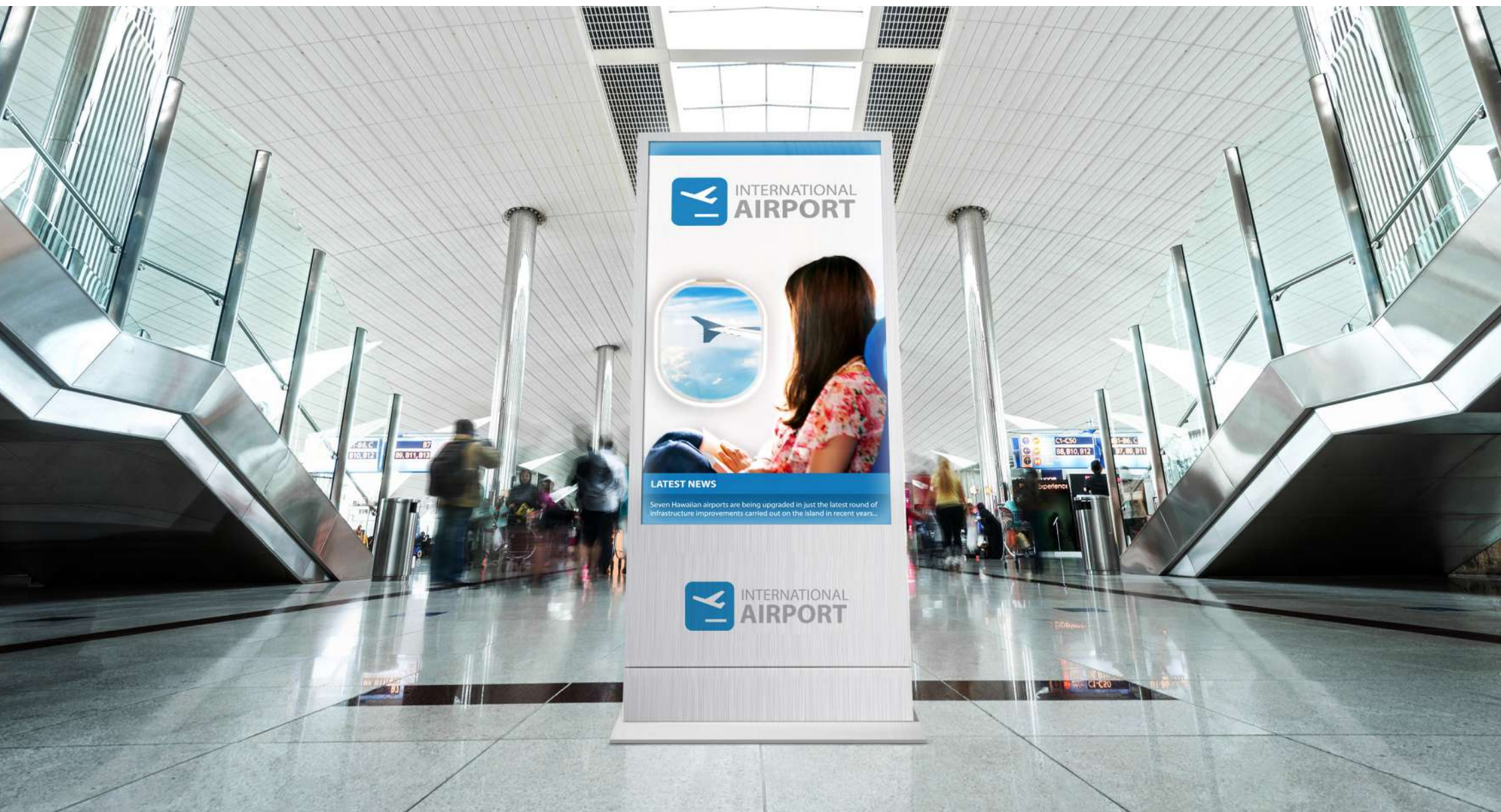

MEDIA TOTEM 65" BIFACCIALE / MEDIA TOTEM 65" DOUBLE-SIDED



MEDIA TOTEM 55" BIFACCIALE MISTO / MEDIA TOTEM 55" DOUBLE-SIDED MIXED



MEDIA TOTEM 55" MONOFACCIALE / MEDIA TOTEM 55" SINGLE-SIDED

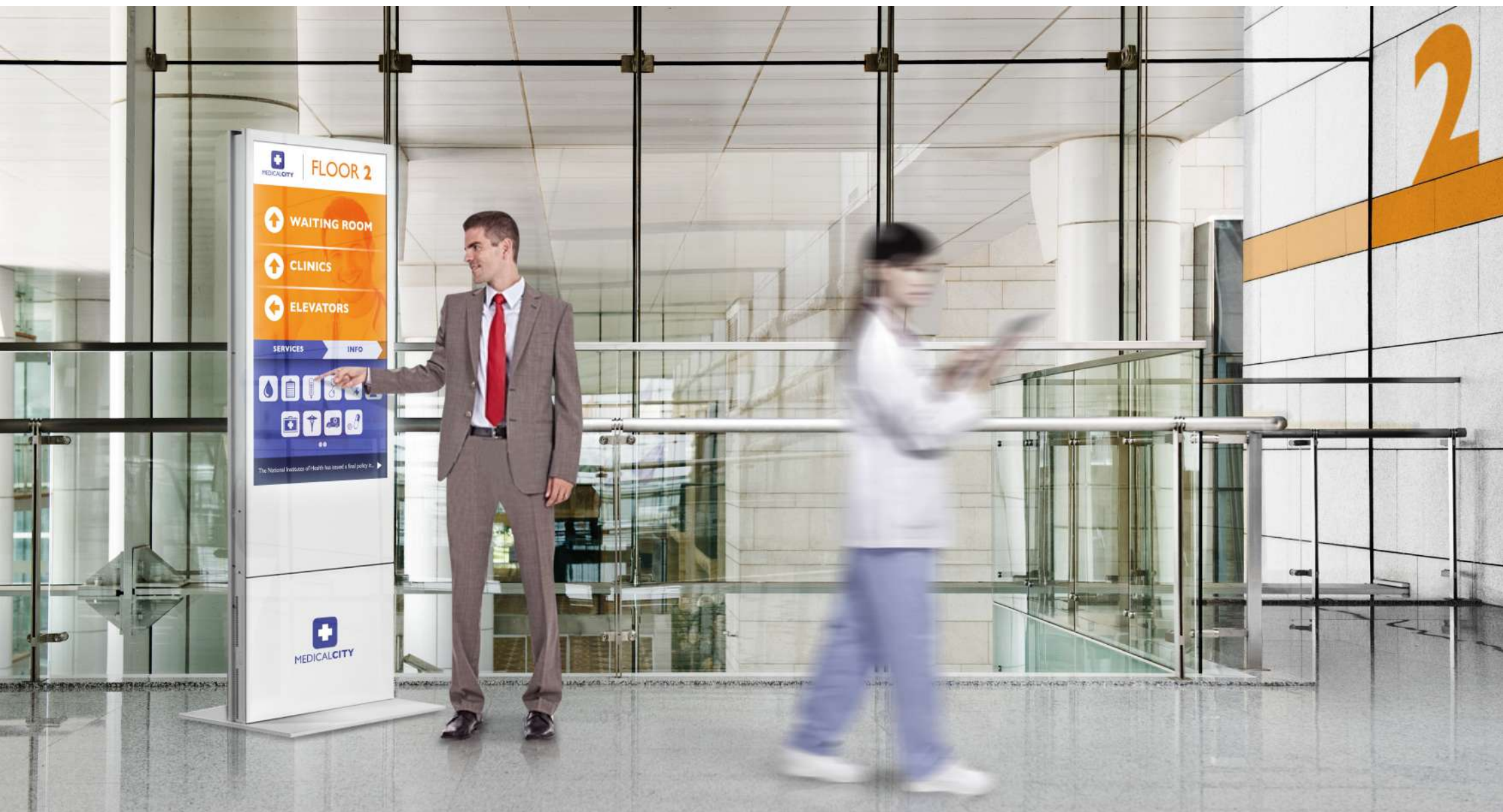

MEDIA TOTEM 55" MONOFACCIALE CON TOUCHSCREEN / MEDIA TOTEM 55" SINGLE-SIDED WITH TOUCHSCREEN



MEDIA TOTEM 55" MONOFACCIALE / MEDIA TOTEM 55" SINGLE-SIDED



FORMATI DISPONIBILI - FINITURA BIANCO LUCIDO
AVAILABLE SIZES - WHITE GLOSSY FINISH

/ MEDIA SOLUTIONS

■ RAL 9010



42"



55"



65"



FORMATI DISPONIBILI - FINITURA NERO LUCIDO
AVAILABLE SIZES - BLACK GLOSSY FINISH

/ MEDIA SOLUTIONS

■ RAL 9005



42"



55"



65"



FORMATI DISPONIBILI - FINITURA ACCIAIO INOX
AVAILABLE SIZES - STAINLESS STEEL FINISH

/ MEDIA SOLUTIONS

FINITURA NON STANDARD (MIN. 10 QUANTITÀ) / NO STANDARD FINISH (MIN. 10 QUANTITIES)



42"



55"



65"



**FRONTE MONOFACCIALE /
FRONT SINGLE-SIDED**



LCD DIGITAL

**RETRO MONOFACCIALE /
BACK SINGLE-SIDED**



OUTPUT AUDIO
Stereo 2x5 W
audio output (L/R)

AUDIO OUTPUT
Stereo 2x5 W
audio output (L/R)

**FRONTE BIFACCIALE MISTO /
FRONT DOUBLE-SIDED MIXED**



LCD DIGITAL

**RETRO BIFACCIALE MISTO /
BACK DOUBLE-SIDED MIXED**



**PANNELLO CAMBIO MESSAGGIO /
MESSAGE CHANGE PANEL**



OUTPUT AUDIO
Stereo 2x5 W
audio output (L/R)

AUDIO OUTPUT
Stereo 2x5 W
audio output (L/R)



PANNELLO CAMBIO MESSAGGIO
Sollevando la cornice magnetica è possibile una rapida sostituzione del messaggio: apri, togli e sostituisci.

MESSAGE CHANGE PANEL
Just raise the magnetic frame and replace the notice: open, remove and insert.



**FRONTE BIFACCIALE MEDIA /
FRONT DOUBLE-SIDED MEDIA**



LCD DIGITAL

**RETRO BIFACCIALE MEDIA /
BACK DOUBLE-SIDED MEDIA**



LCD DIGITAL



OUTPUT AUDIO
Stereo 2x5 W
audio output (L/R)

AUDIO OUTPUT
Stereo 2x5 W
audio output (L/R)

42"

MONOFACCIALE MEDIA / SINGLE-SIDED MEDIA

FRONTE / FRONT: LCD DIGITAL 42"

BIFACCIALE MISTO / DOUBLE-SIDED MIXED

FRONTE / FRONT: LCD DIGITAL 42"

RETRO / BACK: PANNELLO CAMBIO MESSAGGIO 50x70 cm /
MESSAGE CHANGE PANEL 50x70 cm

BIFACCIALE MEDIA / DOUBLE SIDED-MEDIA

FRONTE / FRONT: LCD DIGITAL 42"

RETRO / BACK: LCD DIGITAL 42"

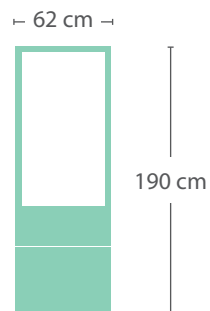

AREA ATTIVA / ACTIVE AREA

52,3x93,1 cm

55"

MONOFACCIALE MEDIA / SINGLE-SIDED MEDIA

FRONTE / FRONT: LCD DIGITAL 55"

BIFACCIALE MISTO / DOUBLE-SIDED MIXED

FRONTE / FRONT: LCD DIGITAL 55"

RETRO / BACK: PANNELLO CAMBIO MESSAGGIO 70x100 cm /
MESSAGE CHANGE PANEL 70x100 cm

BIFACCIALE MEDIA / DOUBLE-SIDED MEDIA

FRONTE / FRONT: LCD DIGITAL 55"

RETRO / BACK: LCD DIGITAL 55"

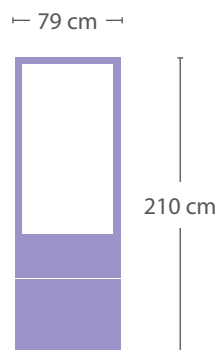

AREA ATTIVA / ACTIVE AREA

68,1x121 cm

65"

MONOFACCIALE MEDIA / SINGLE-SIDED MEDIA

FRONTE / FRONT: LCD DIGITAL 65"

BIFACCIALE MISTO / DOUBLE-SIDED MIXED

FRONTE / FRONT: LCD DIGITAL 65"

RETRO / BACK: PANNELLO CAMBIO MESSAGGIO 70x100 cm /
MESSAGE CHANGE PANEL 70x100 cm

BIFACCIALE MEDIA / DOUBLE-SIDED MEDIA

FRONTE / FRONT: LCD DIGITAL 65"

RETRO / BACK: LCD DIGITAL 65"

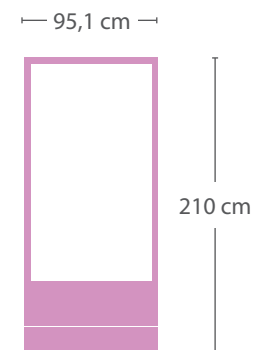

AREA ATTIVA / ACTIVE AREA

80,3x142,8 cm

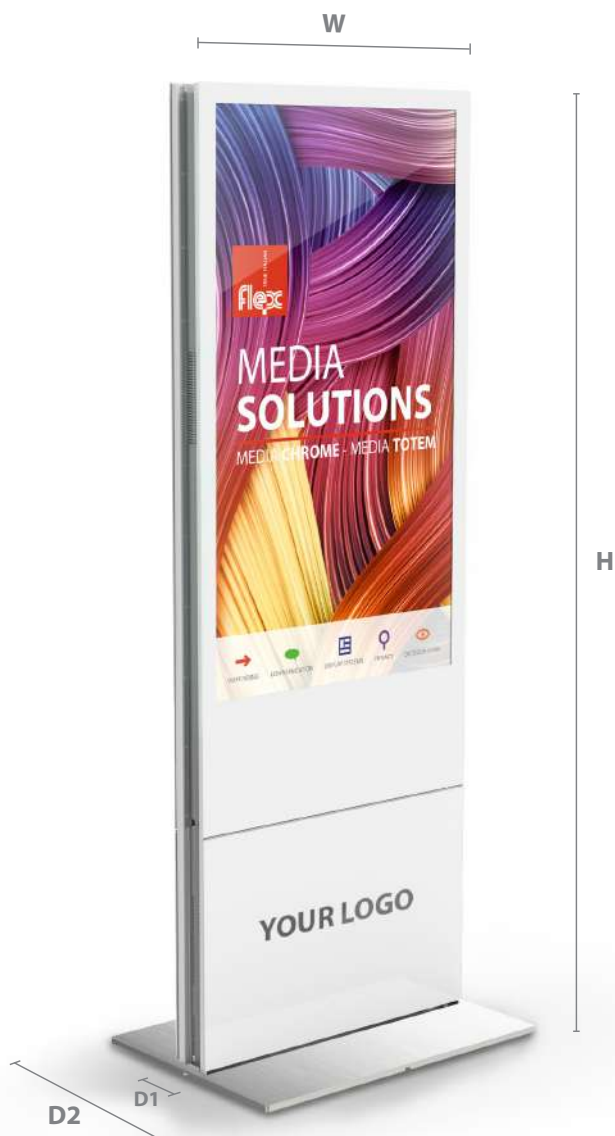

	42"	55"	65"
DIMENSIONE DISPLAY / DISPLAY SIZE	42"	55"	65"
AREA ATTIVA / ACTIVE AREA	52,4x93,1 cm	68,1x121 cm	80,3x142,8 cm
RISOLUZIONE / RESOLUTION	1920x1080 px	1920x1080 px	1920x1080 px
PROPORZIONE / ASPECT RATIO	Wide 16:9	Wide 16:9	Wide 16:9
LUMINOSITÀ MASSIMA / MAX BRIGHTNESS	700 cd/m ²	700 cd/m ²	700 cd/m ²
RETROILLUMINAZIONE / BACKLIGHT	LEDedge	LEDedge	LEDedge
CONTRASTO / CONTRAST	4000:1 (typ)	4000:1 (typ)	4000:1 (typ)
ANGOLO DI VISIONE / VIEWING ANGLE	178°/178°	178°/178°	178°/178°
DURATA LUMINOSITÀ OTTIMALE* / OPTIMAL BRIGHTNESS DURATION*	50.000 h	50.000 h	50.000 h
LARGHEZZA / WIDTH (W)	62 cm	79 cm	98 cm
ALTEZZA / HEIGHT (H)	190 cm	210 cm	210 cm
PROFONDITÀ / DEPTH (D1)	9 cm	9 cm	14 cm
PROFONDITÀ BASE / BASE DEPTH (D2)	55 cm	55 cm	65 cm
ALTEZZA BASE / BASE HEIGHT	1 cm	1 cm	1 cm
POTENZA ASSORBITA / POWER COM. (TYP.)	100 W	125 W	250 W
POTENZA ASSORBITA BIFACCIALE / DOUBLE-SIDED POWER COM. (TYP.)	200 W	250 W	500 W
TEMPERATURA DI ESERCIZIO / OPERATIONAL TEMPERATURE	+0°/+40° C	+0°/+40° C	+0°/+40° C
TEMPERATURA DI STOCCAGGIO / STORAGE TEMPERATURE	-20°/+50° C	-20°/+50° C	-20°/+50° C
PESO / WEIGHT	85 kg	116 kg	142 kg
PESO BIFACCIALE / DOUBLE-SIDED WEIGHT	103 kg	156 kg	210 kg

* Periodo oltre al quale la luminosità del display scende al di sotto del 50% rispetto al suo valore originale.

* Period over which the brightness of the display falls below 50% compared to its original value.

VERSIONE STANDARD (MXP)

La versione STANDARD MXP del MEDIA TOTEM è ideale per la comunicazione di contenuti a pieno schermo, quali immagini e filmati con audio in alta risoluzione. Permette inoltre la visualizzazione contemporanea di diversi contenuti tramite la suddivisione del video in più aree. I contenuti memorizzati internamente al MEDIA TOTEM possono essere riprodotti in modo ciclico o secondo una programmazione del palinsesto, definita tramite un apposito software previsto a corredo della fornitura.

L'aggiornamento può avvenire tramite server FTP o tramite chiavetta USB.

The STANDARD MXP version of MEDIA TOTEM is ideal for the communication of contents at full screen such as high resolution images and movies with audio. It also allows the simultaneous display of different contents by splitting the video into different areas. The contents stored into MEDIA TOTEM can be played in loop or according to a schedule defined using a dedicated software provided with the totem.

The uploads of contents through FTP server or USB key.



VERSIONE STANDARD (VIDEOPOSTER)

Nelle versioni STANDARD VIDEOPOSTER del MEDIA TOTEM, oltre a immagini e filmati, possono essere visualizzati testi scorrevoli, feed RSS o contenuti inseriti in pagine dinamiche (linguaggio HTML5). Possono essere utilizzati contenuti in streaming da IP locali e di rete.

La definizione e l'aggiornamento di palinsesti e layout viene effettuato mediante l'apposito software o tramite chiavetta USB.

In the STANDARD VIDEOPOSTER version of MEDIA TOTEM, as well as images and videos, user can visualize live text, RSS feeds or contents of dynamic pages (HTML5 language). User can also use streaming contents from local or network IP. The definition and the update of schedule and layout is done by a dedicated software and only via network or USB key.



VERSIONE ADVANCED (NUC I5)

La versione ADVANCED del MEDIA TOTEM è dotata di un PC interno Intel, con sistema operativo Windows (opzionale) e consente di collegare tutti i dispositivi compatibili.

Il touchscreen, previsto come optional, consente l'interazione diretta dell'utente.





























NOTA: in questa versione non viene incluso alcun software di digital signage o di gestione contenuti.

The ADVANCED version of MEDIA TOTEM has an internal Intel PC with Windows operating system (optional) and allows the connection of all the compatible devices.

The optional touchscreen allows direct user interaction.

NOTE: this release does not include any software or digital signage content management.



	STANDARD (MXP)	STANDARD (VIDEOPOSTER)	ADVANCED (NUC I5)
 TOUCHSCREEN - TECNOLOGIA CAPACITIVA 40 TOCCHI / TOUCHSCREEN - CAPACITIVE TECHNOLOGY 40 TOUCHES			
 Upgrade Media Player NUC I7 Scheda Integrata IntelCore i7 / Upgrade Media Player NUC I7 Integrated Board Intel Core i7			
 SOFTWARE UPGRADE CLOUD SOLUTION*			
 SYNCHRO ADD-ON**			
 HDMI IN AUTOSWITCHING***			
 PERSONALIZZAZIONE VETRO FRONTALE (min. 10 pezzi) / FRONTAL GLASS CUSTOMIZATION (min. 10 pieces)			
 PERSONALIZZAZIONE LOGO CLIENTE / CLIENT LOGO CUSTOMIZATION			

 OPTIONAL SOFTWARE / SOFTWARE OPTIONALS

 OPTIONAL STRUTTURALI / STRUCTURAL OPTIONALS

*Costo servizio Cloud escluso / Cost of Cloud service excluded

**Per sincronizzare due o più Media Chrome / To synchronize two or more Media Chrome

***Nella versione Standard Videoposter già incluso / In the Standard Videoposter version already included



CARATTERISTICHE / FEATURES	STANDARD MXP	STANDARD VIDEOPOSTER	ADVANCED NUC 15
Sistema Operativo - Licenze / Operation System - License	Sistema Linux Incluso / Linux Based Included free	Sistema Linux Incluso / Linux Based Included free	Windows 10
Wi-Fi	Incluso / Included	Incluso / Included	Incluso / Included
HDMI IN Autoswitching	YES (Optional)	Incluso / Included	YES (Optional)
HDMI OUT	NO	NO	YES
Gestione delle periferiche (stampanti, lettori ottici, webcam, touch, ecc.)/ Device management (printers, optical readers, webcam, touch, etc.)	NO	NO	YES
Caricamento tramite USB/ Uploading by USB	YES	YES	YES
Caricamento tramite NET/ Uploading by NET	NO	YES	YES
Caricamento tramite FTP/ Uploading by FTP	YES	NO	YES
Sincronizzazione (versioni bifacciali o più schermi) / Synchro (double-sided versions or more screens)	YES	NO	NO
Divisione schermi / Screen divisions	YES	NO	Specifico software (non incluso) / Specific software (not included)
File video	YES	YES	YES
File Immagine / File Image	YES	YES	YES
Altri Files / Other Files	NO	Pdf	Tutti i tipi con specifico software (non incluso) / All types with specific software (not included)
Configurazione/ Configuration	solo Software / Software only	Software e pagina Web / Software and Web page	politica Windows / Windows policy
Gestione/ Management	solo Software / Software only	Software e pagina Web / Software and Web page	politica Windows / Windows policy
Software	Configuratore MXP / MXP Configurator	ACC	-



Elevata luminosità con consumi contenuti ed ecosostenibili /
High brightness with low power and sustainable consumption



Lifetime elevato
(50.000 - 60.000 ore) /
High lifetime
(50.000 - 60.000 hours)



Gestione remota tramite rete e semplicità di utilizzo del software /
Remote easy to use management network and software



Compatibilità con sorgenti video esterne (tablet e PC) /
Compatibility with external video sources (other devices or PCs)



Porta frontale apribile per una semplice manutenzione /
Openable front door for easy maintenance



Vetro frontale temperato /
Frontal tempered glass



Spessore di soli 10 cm anche nella versione bifacciale /
Thickness of only 10 cm also in double-sided version



Media player integrato /
Built in media player



INTERACTIVE KIOSK

43"

IT | L'**INTERACTIVE KIOSK** è una **perfetta combinazione di tecnologia, fruibilità e design, particolarmente adatto per applicazioni multimediali** dove è necessario dare un valore aggiunto alle proprie comunicazioni. È disponibile con un display da 43" provvisto di **touchscreen dodici tocchi** e una ricca gamma di opzioni utili, per venire incontro a tutte le applicazioni di self-service e segnaletica direzionale. I compartimenti posteriori sono accessibili per garantire **semplici e veloci operazioni di manutenzione**. Con questa soluzione è possibile consultare brochure o cataloghi digitali, video e contenuti multimediali interattivi.

EN | The **INTERACTIVE KIOSK** is a **perfect combination of technology, usability and design, particularly suitable for multimedia applications** where it is necessary to have added value to your communications. It is available with a 43" display provided of **twelve touches touchscreen** and a rich set of useful options, to meet all self-service and wayfinding applications. The rear compartments are accessible in order to perform **simple and fast maintenance operations**. With this solution it is possible to consult digital brochures or catalogues, video and interactive multimedia contents.



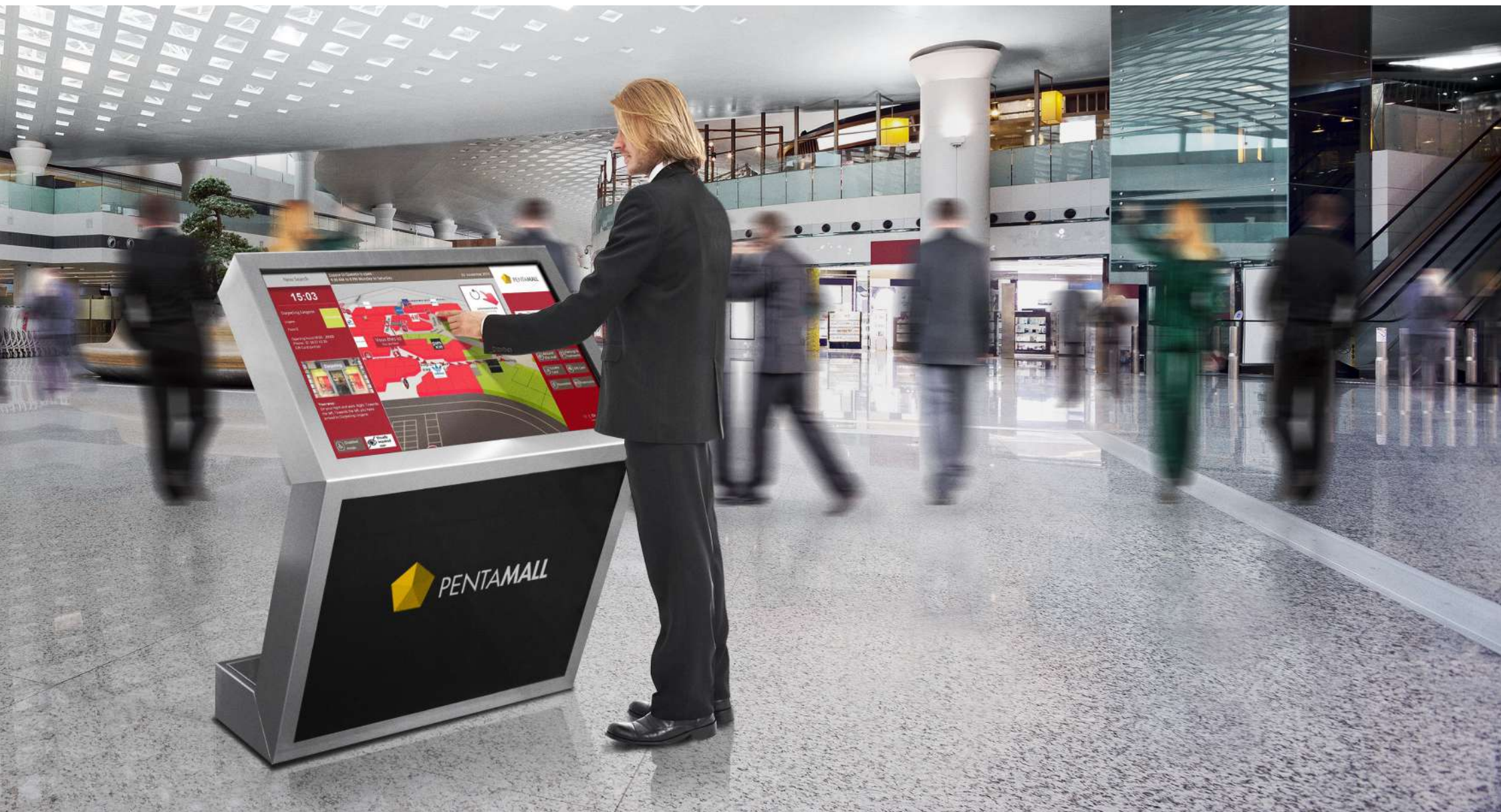

KIOSK 43" / KIOSK 43"



KIOSK 43" / KIOSK 43"



43"

43"

MONOFACCIALE MEDIA / SINGLE-SIDED

FRONTE / FRONT: LCD DIGITAL 43"

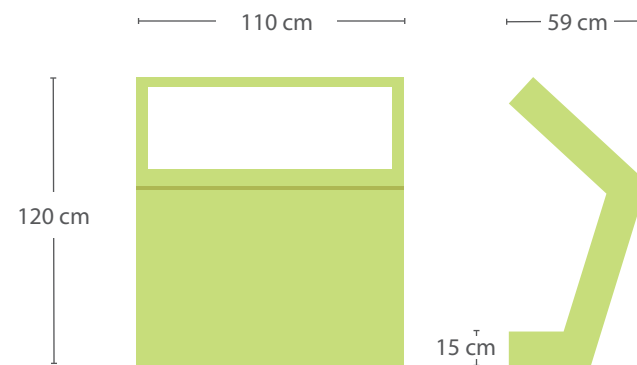

AREA ATTIVA / ACTIVE AREA

94,3x53,1 cm

FRONTE /
FRONT

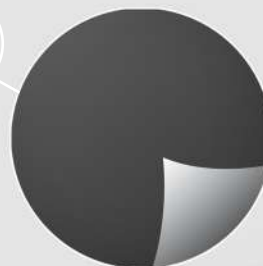

PELLICOLA
PERSONALIZZABILE

CUSTOMIZABLE
FILM

RETRO /
BACK

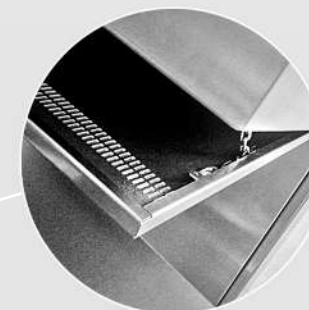

**PORTA APRIBILE
PER MANUTENZIONE**

Area apribile per una facile e
veloce manutenzione.

**OPENABLE DOOR
FOR MAINTENANCE**

Openable area for easy and
fast maintenance.



43"

DIMENSIONE DISPLAY / DISPLAY SIZE	43"
AREA ATTIVA / ACTIVE AREA	94,3x53,1 cm
RISOLUZIONE / RESOLUTION	1920x1080 px
PROPORZIONE / ASPECT RATIO	Wide 16:9
LUMINOSITÀ MASSIMA / MAX BRIGHTNESS	400 cd/m ²
RETROILLUMINAZIONE / BACKLIGHT	LEDedge
CONTRASTO / CONTRAST	1100:1 (typ)
ANGOLO DI VISIONE / VIEWING ANGLE	178°/178°
DURATA LUMINOSITÀ OTTIMALE* / OPTIMAL BRIGHTNESS DURATION*	50.000 h
LARGHEZZA / WIDTH (W)	110 cm
ALTEZZA / HEIGHT (H)	120 cm
PROFONDITÀ / DEPTH (D)	59 cm
POTENZA ASSORBITA / POWER COM. (TYP.)	124 W
TEMPERATURA DI ESERCIZIO / OPERATIONAL TEMPERATURE	0°/+40° C
TEMPERATURA DI STOCCAGGIO / STORAGE TEMPERATURE	-20°/+60° C
PESO / WEIGHT	95 kg
TOUCHSCREEN IR / IR TOUCHSCREEN	12 tocchi / 12 touches

* Periodo oltre al quale la luminosità del display scende al di sotto del 50% rispetto al suo valore originale.

* Period over which the brightness of the display falls below 50% compared to its original value.

	Upgrade Media Player NUC I5 Scheda Integrata - Intel Core i5 / Upgrade Media Player NUC I5 Integrated Board - Intel Core i5
	Ram 4GB - Disco fisso SSD 64GB / Ram 4GB - Hard Disk SSD 64GB
	WINDOWS WIN 10 IoT Enterprise
	ROUTER M2M 3G / 4G
	AUDIO 2x5 W
	Upgrade Media Player NUC I7 Scheda Integrata - Intel Core i7 / Upgrade Media Player NUC I7 Integrated Board - Intel Core i7
	WEBCAM - LOGITECH HD C920 - Full HD 1080p
	Sensore di Prossimità / Proximity IR sensor
	Sensore Anti-Urto / Shock Sensor
	Lettore Codice a barre. Laser scanner 1D-2D, Scan rate: 200dpi, RS232, USB-HID / Bar Code reader. Laser scanner 1D-2D, Scan rate: 200dpi, RS232, USB-HID.
	Lettore hybrid card. MagneticCard (ISO7811) - SmartCard (ISO7816) - cpu/memory card / Hybrid card reader. MagneticCard (ISO7811) - SmartCard (ISO7816) - cpu/memory card.
	Lettore NFC - usb - velocità 12Mbps; distanza operativa 50 mm - Supporto Interfaccia SmartCard: ISO14443 Tipo A & BMIFAREFeliCa 4 tipi di NFC (ISO/IEC18092) / NFC reader - usb - 12Mbps speed; oper. distance 50 mm - SmartCard Interface Support: ISO14443 Type A & BMIFAREFeliCa 4 types of NFC (ISO/IEC18092) tags

	Sistema di pagamento elettronico (antivandal). Tastiera in acciaio inossidabile con display monocromatico da 2,5" + lettore Magnetic & Smartcard (Contactless escluso, + 230 € al prezzo di listino) / Electronic Payment System (antivandal). Stainless steel pin pad with monochromatic 2,5" display + Magnetic & Smartcard reader (no contactless included +230€ list price)
	Sistema di pagamento elettronico. Tastiera con display a colori da 3,5", con smart card e contactless / Electronic Payment System. Pin pad with color 3,5" display, with smart card & contactless
	Stampate Termica - larghezza carta: 80mm, 8dot/mm, velocità: 150 mm/sec, Interfacce RS232 e USB / Thermal printer - paper width: 80mm, 8dot/mm, speed: 150 mm/sec, Interfaces RS232 e USB
	Stampate Termica - formato carta: A4, 300 dpi, velocità: 180 mm/sec, Interfacce RS232 e USB / Thermal printer - paper format: A4, 300dpi, speed: 180 mm/sec, Interfaces RS232 e USB
	Fotocamera Scanner A4 - Risoluzione 1080p HD / A4 Scanner Camera - 1080p HD Resolution
	Gruppo di continuità 600VA / UPS 600VA
	PERSONALIZZAZIONE COLORE STRUTTURA (BIANCO/NERO) / STRUCTURE COLOR CUSTOMIZATION (WHITE/BLACK)
	PERSONALIZZAZIONE LOGO CLIENTE (stampa digitale) / CLIENT LOGO CUSTOMIZATION (digital printed)
	Scocca esterna per sensore di prossimità e fotocamera / External Case for proximity sensor and camera
	Porta frontale per stampante e lettori carta / Frontal door for printer and card reader

SOFTWARE APPLICATIVI (WAYFINDING, DIGITAL SIGNAGE) **NON INCLUSI** /
APPLICATION SOFTWARE (WAYFINDING, DIGITAL SIGNAGE) **NOT INCLUDED**

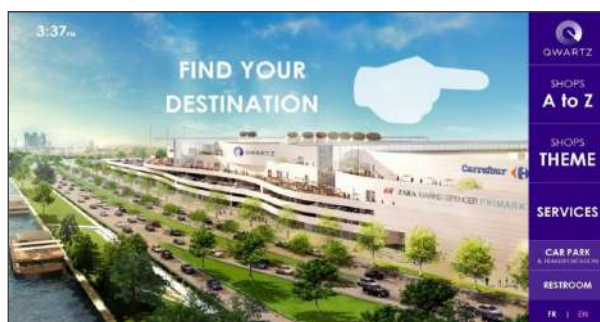
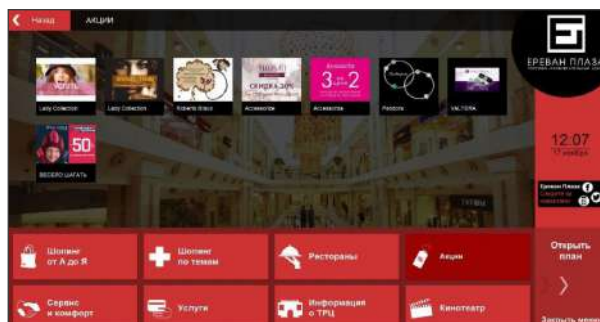

SOFTWARE APPLICATIVI (WAYFINDING, DIGITAL SIGNAGE) **NON INCLUSI** /
APPLICATION SOFTWARE (WAYFINDING, DIGITAL SIGNAGE) **NOT INCLUDED**

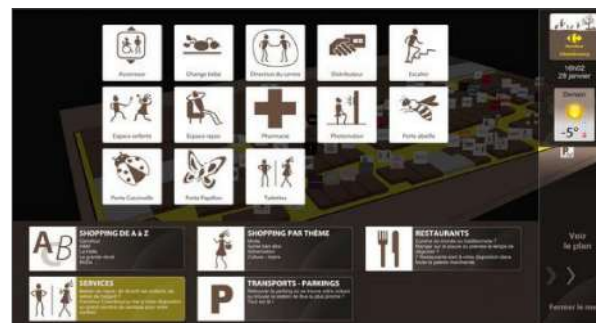



**MAPPA 3D MULTI_TOUCH E INTERATTIVA /
MULTI-TOUCH AND INTERACTIVE 3D MAP**

Percorsi orientati nella direzione dell'utente /
Routes oriented towards the user's view
Multi-piani e multi-edifici /
Multi-floors and multi-building



**RICERCA PREDITTIVA PER PAROLE CHIAVE /
PREDICTIVE SEARCH BY KEYWORDS**

Testo descrittivo, foto e video /
Descriptive text, photos and videos
Tastiera virtuale, selezione di lettera o categoria /
Virtual keyboard, letter or category selection
Numero illimitato di destinazioni /
Unlimited number of destinations



**SERVIZI E INFORMAZIONI /
SERVICES AND INFORMATION**

Banco informazioni, area Wi-Fi /
Information desk, Wi-Fi area
Parcheggio auto, bus navetta gratuito /
Car park, free shuttle bus
Eventi, notizie, migliori offerte /
Events, news, best deals



**SERVER PER LA GESTIONE DEI CONTENUTI /
CONTENT MANAGEMENT SERVER**

Gestione e programmazione della pubblicità /
Advertising management and scheduling
Aggiornamento dei contenuti delle mappe /
Map content update
Monitoraggio e gestione dei diritti di accesso /
Monitoring and access right management
Statistiche avanzate e relazioni /
Advanced statistics and reporting



**BANCA DATI E INFORMAZIONI LIVE /
DATABASE AND LIVE INFORMATION**

Pianificazione dei trasporti e orari dei film /
Transportation schedules and movies' timetables
Meteo, traffico, qualità dell'aria, data e ora /
Weather, traffic, air quality, date and time
Terze parti: prenotazione delle sale riunioni /
Third parties: meeting room booking
Ristoranti e hotel /
Restaurants and hotels



**CAMPAGNE DI MARKETING /
MARKETING PROMOTIONS**

Gestione della carta fedeltà /
Loyalty card management
Sondaggi e questionari /
Surveys and questionnaires



**SISTEMA CLOUD /
CLOUD SYSTEM**

Strumento di gestione sicuro per aggiornare e controllare tutti i dispositivi basato sul cloud /

Secure and cloud based management tool to update and control all devices



**GESTIONE DISPOSITIVI /
DEVICE MANAGEMENT**

Un sistema di back-office unico per tutte le piattaforme /

A unique back-office system for all platforms



**MULTILINGUE /
MULTILINGUAL**

Italiano, Arabo, Russo, Ceco, Tedesco, Francese, Spagnolo, Olandese, Mandarino, e altro /

Italian, Arabic, Russian, Czech, German, French, Spanish, Dutch, Mandarin, and more



**MULTICANALE /
MULTI-CHANNEL**

Kiosk, sito web e app per smartphone /

Kiosk, website and mobile app



**ACCESSIBILE A TUTTI /
ACCESSIBLE TO ALL**

Visualizzazione ottimale per gli ipovedenti /

Optimized display for the visually impaired

Percorsi alternativi per persone disabili /

Alternative routes for disabled people

Facile da leggere e contenuto ergonomico /

Easy to read and ergonomic content



FLEX s.r.l.

Via G. Bargnani, 11

25135 Brescia (BS) - Italy

Phone +39 030 35.310.05

Fax +39 030 35.310.22

www.flex.it - info@flex.it